

Studio Due[®]

emotion and creativity in light

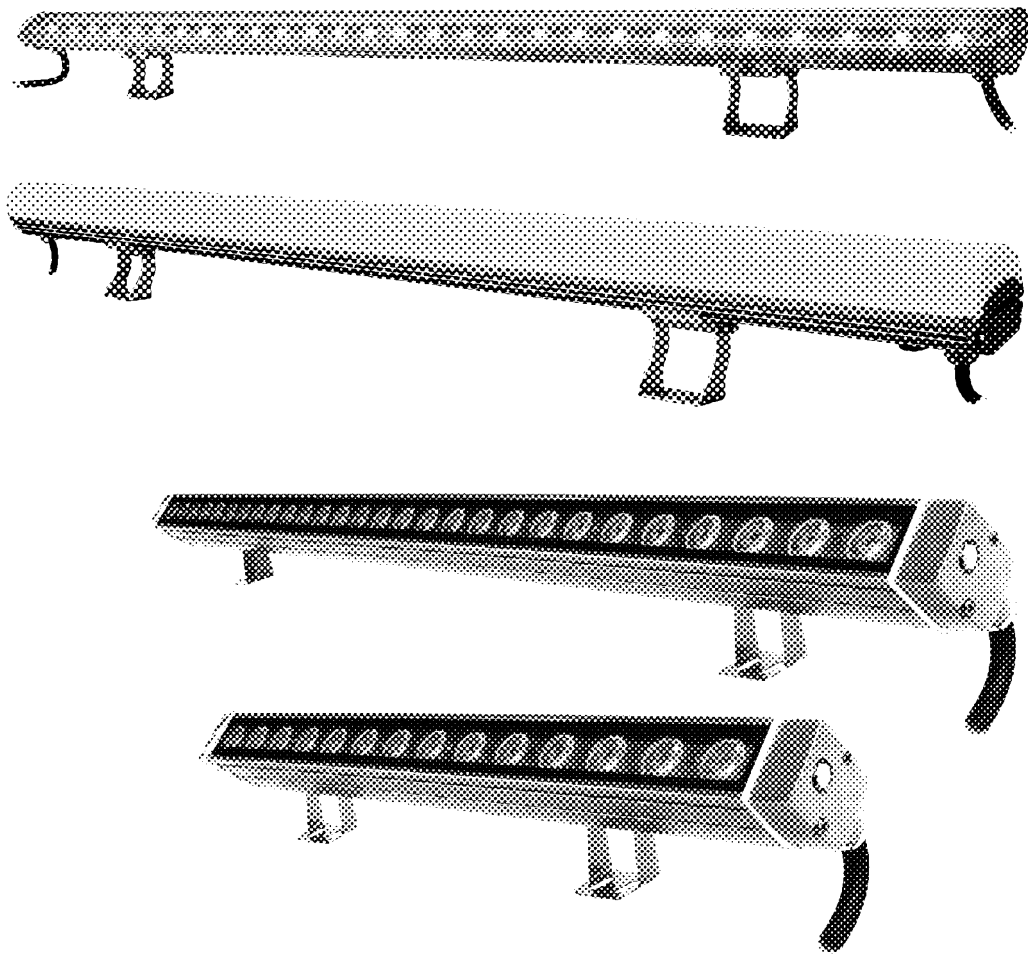

slimbar **slimbar**
PLUS FLAT
SB-pilot

User manual - Manuale d'uso
art. SLIMBAR PLUS - SLIMBAR FLAT

SLIMBAR PLUS



SLIMBAR PLUS rgbw

SLIMBAR PLUS monochromatic



PHYSICAL / MISURE

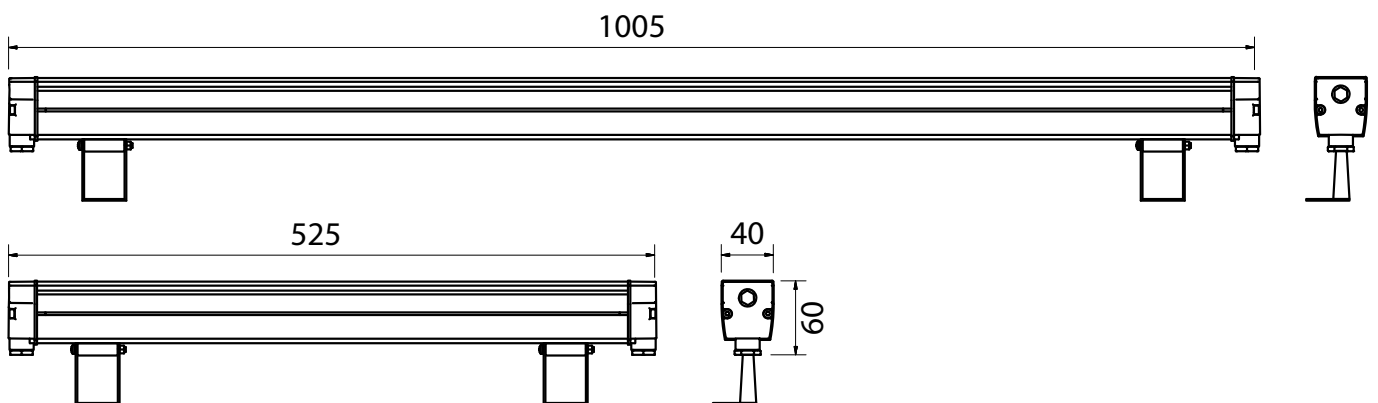

connectors only for SLIMBAR PLUS

IN/OUT IP67 connectors - Connettori IP67 IN/OUT

MONOCHROMATIC fixture

MALE - INPUT connector

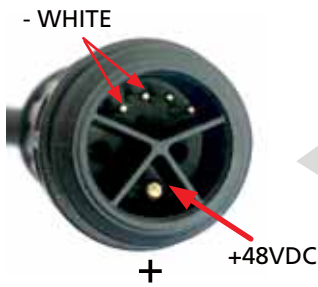

input connector front view

input connector rear side welding view

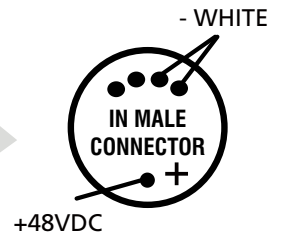

FEMALE - OUTPUT connector



output connector front view

output connector rear side welding view

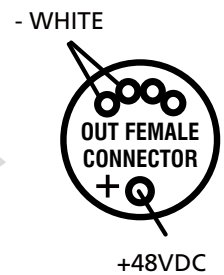

included with the fixture - incluso nell'apparecchio

art. 5PIN IP67 CONNECTORS

If you want to connect the fixtures for **OUTDOOR** use, you can make a new cable utilizing this connectors

The cable is not included with the connectors kit



Se volete utilizzare gli apparecchi all'**ESTERNO**, potete realizzare dei nuovi cavi con questi connettori

Il cavo non è incluso nel kit dei connettori

RGBW fixture

MALE - INPUT connector

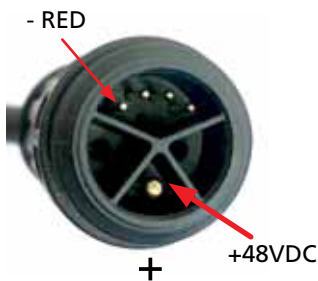

input connector front view

input connector rear side welding view

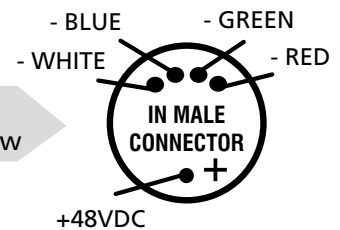

FEMALE - OUTPUT connector

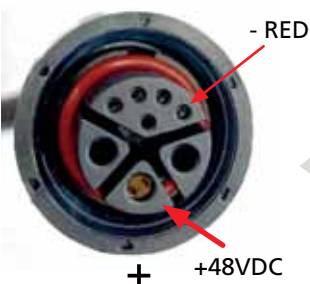

output connector front view

output connector rear side welding view

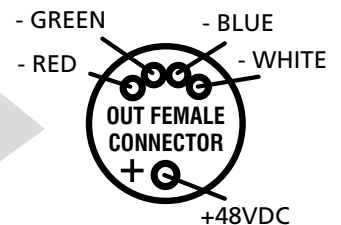

SLIMBAR FLAT



SLIMBAR FLAT rgbw



OPTIONAL milky diffuser



SLIMBAR FLAT monochromatic

PHYSICAL / MISURE

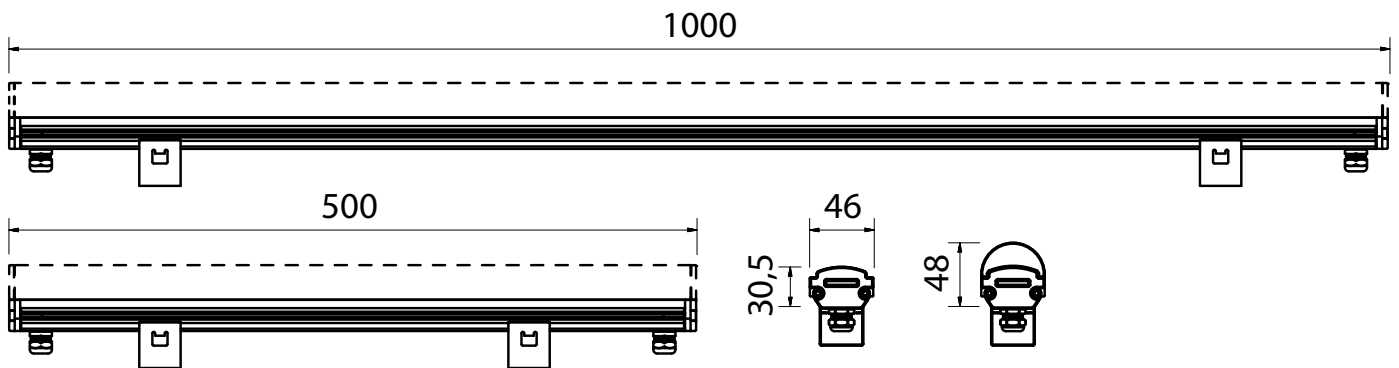

connectors only for SLIMBAR FLAT

IN/OUT IP67 connectors - Connettori IP67 IN/OUT

MONOCHROMATIC fixture

MALE - INPUT connector

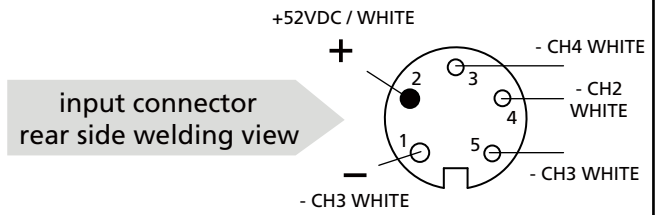
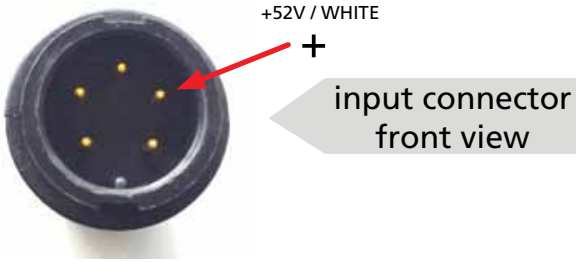

FEMALE - OUTPUT connector

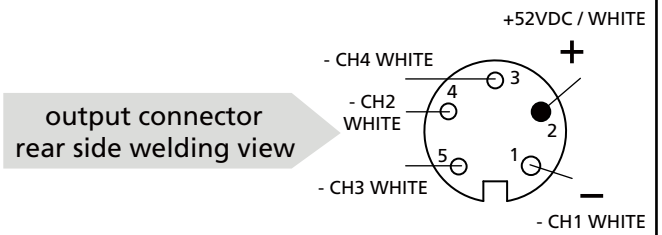

endowed with the fixture - incluso nell'apparecchio

art. 5PIN IP67 CONNECTORS

If you want to connect the fixtures for **OUTDOOR** use, you can make a new cable utilizing this connectors

The cable is not endowed with the connectors kit



Se volete utilizzare gli apparecchi all'**ESTERNO**, potete realizzare dei nuovi cavi con questi connettori

Il cavo non è incluso nel kit dei connettori

RGBW fixture

MALE - INPUT connector

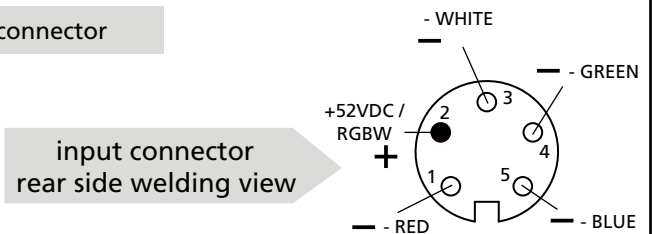

FEMALE - OUTPUT connector

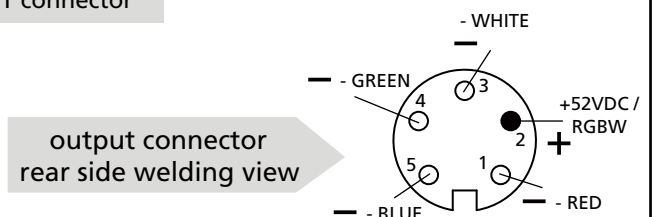
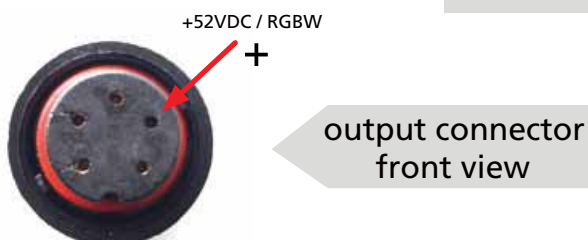

INDEX / INDICE

Page 2 - Physical / Misure

Page 7 - Safety informations / Informazioni di sicurezza

Page 8 - Introduction / Introduzione

Page 9 - Technical features / Caratteristiche tecniche

Page 11 - Connections / Conessioni

Page 13 - Setup and Configuration / Settaggio e Configurazione

Page 14 - DRS functioning / Funzioni DRS

Page 15 - Slimbar DRS menu list / Lista menu Slimbar DRS

Page 20 - Example of connection DMX controller-driver / Esempio di collegamento centralina DMX-driver

Page 21 - Slimbar Pilot example of connections / Esempi di connessioni Slimbar Pilot

Page 28 - Warranty / Garanzia

Page 29 - CE standards / Certificazioni CE

**WARNING****SAFETY INFORMATION (service personnel)**

READ ALL CAUTIONS AND WARNINGS PRIOR TO OPERATE THIS EQUIPMENT.
INSTRUCTION TO PREVENT INJURY OR DAMAGE DUE TO ELECTRIC SHOCK, FIRE, MECHANICAL HAZARDS,
DANGEROUS MATTERS.

•PROTECTION AGAINST DANGEROUS MATTERS

At the end of its life, must be collected separately. It shouldn't be thrown as urban waste and neither released in the environment.

It must be collected from the nearest special waste collection point or consigned to your dealer that provides the service. The incorrect waste disposal can damage the environment and the people for the presence of dangerous substances. Sanctions are provided for an unauthorized disposal.

**•PROTECTION AGAINST FIRE**

- 1) Maintain minimum distance of 0,1 meter to lighted objects.
- 2) Replace fuses (if present) only with the specified type and rating.
- 3) Do not install the fixture close to heat sources. Do not lay the connection cable on the fixture when it is warm.
- 4) Fixture designed to be installed on normally flammable surfaces.

•PROTECTION AGAINST ELECTRIC SHOCK

- 1) This equipment must be earthed.
- 2) Class I equipment. The power supply cord includes a protective earthing conductor as part of the cord.
- 3) Disconnect power before servicing (service personnel).
- 4) To replace the LEDs, contact: Studio Due Trade Srls.
- 5) If the external flexible cable of this appliance is damaged, it must only be replaced by the manufacturer, its assistance service, or equivalent qualified personnel, in order to avoid dangers.

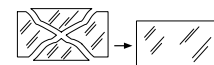
**•PROTECTION AGAINST MECHANICAL HAZARDS**

- 1) Use secondary safety chain when fixing this equipment.
- 2) The protection screens and the lenses must be replaced with genuine parts only if they are visibly damaged and their effectiveness has been reduced, for example, by cracks or deep scratches.
- 3) Do not look directly into the illuminated LEDs of the product for long periods of time. LED lamps can cause eye damage or irritation. Do not look directly into the light source using an optical instrument that focuses on the light beams.



The device should be positioned so that there is no prolonged observation of the device at a distance of less than 100cm. (RG1 – IEC/TR 62778:2014).

**IMPORTANTE****INFORMAZIONI DI SICUREZZA (personale di servizio)**

LEGGERE ATTENTAMENTE TUTTI GLI AVVERTIMENTI PRIMA DI COMPIERE QUALUNQUE OPERAZIONE SU QUESTO APPARECCHIO. ISTRUZIONI PER PREVENIRE LESIONI O DANNI DOVUTI AL FUOCO, ALLE SCOSSE ELETTRICHE, AI RISCHI MECCANICI ED A SOSTANZE PERICOLOSE.

•PROTEZIONE CONTRO SOSTANZE PERICOLOSE

A fine vita è oggetto di raccolta separata, non gettare nei comuni cassonetti di rifiuti urbani, né tantomeno nell'ambiente. Può essere consegnato presso gli appositi centri di raccolta differenziata predisposti dalle amministrazioni comunali, oppure presso i rivenditori che forniscono questo servizio. Lo smaltimento errato può causare danni alle persone e all'ambiente per la possibile presenza di sostanze pericolose. Sono previste sanzioni in caso di smaltimento abusivo dei suddetti prodotti.

**•PROTEZIONE CONTRO IL FUOCO**

- 2) Mantenere la distanza minima di 0,1 metri dagli oggetti illuminati.
- 3) Sostituire i fusibili (se presenti) solo con altri dello stesso tipo e valore.
- 4) Non installare il faro vicino fonti di calore. Non appoggiare il cavo di connessione sul faro quando questo è caldo.
- 5) Questo apparecchio è adatto per il montaggio su superfici normalmente incombustibili.

•PROTEZIONE CONTRO SCOSSE ELETTRICHE

- 1) Questo apparecchio necessita di messa a terra.
- 2) Apparecchio di Classe I. Il conduttore di protezione deve far parte del cavo di alimentazione.
- 3) Disconnettere l'alimentazione prima di aprire l'apparecchio (personale di servizio).

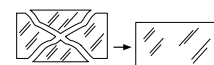
**•PROTEZIONE CONTRO RISCHI MECCANICI**

- 1) Usare la catena di sicurezza supplementare quando installate il faro.
- 2) Gli schermi di protezione e le lenti devono essere sostituiti sempre con ricambi originali se sono visibilmente danneggiati e se la loro efficacia è stata ridotta, per esempio, da fessure o incisioni profonde.
- 3) Non guardare direttamente nei LED illuminati del prodotto per lunghi periodi di tempo. Le lampade a LED possono causare danni o irritazione agli occhi. Non guardare direttamente nella sorgente luminosa utilizzando uno strumento ottico che si concentra sui fasci di luce. L'apparecchio dovrebbe essere posizionato in modo che non sia prevista un'osservazione prolungata dell'apparecchio ad una distanza inferiore di 100cm. (RG1 – IEC/TR 62778:2014).



INTRODUCTION

Thanks for using SLIMBAR FLAT / SLIMBAR PLUS, an ultra small form factor LED LINEAR BAR with IP67 rating protection. This kind of LED bar series is suitable for accent lighting.

Available in two light source:

- RGBW with high efficiency RGBW LEDs
 - MONOCHROMATIC or WHITE BALANCE with monochromatic high efficiency LEDs.
- Available in 2 different measures, 100cm. and 50cm. Standard fixture finishing is grey.

- Art. 171045-171042: SLIMBAR FLAT/RGBW
- Art. 171215-171212: SLIMBAR FLAT/WB (white balance)
- Art. 171115-171112: SLIMBAR FLAT/M (monochromatic)
- Art. 201215-201212: SLIMBAR PLUS/RGBW (differs from Slimbar Flat for the use of optics)
- Art. 201615-201612: SLIMBAR PLUS/WB (differs from Slimbar Flat for the use of optics)
- Art. 201415-201412: SLIMBAR PLUS/W (differs from Slimbar Flat for the use of optics)

To make the most of its possibilities and for a correct functioning of this unit in the years to come, we suggest you to read carefully this manual before connecting or putting the spot into use. By doing so you will gain experience with its commands and connections and you will be easily able to use it.

YOUR REFERENCE

Always remember to give the serial number and to specify the model any time you address the seller for information or assistance.

BASIC KIT

- Projector
- User's manual
- CE standard
- Studio Due warranty



Check that the fixture has not been damaged during transport. If it has been damaged or it does not work, address the seller. Whether the fixture has been shipped to you directly, please contact the shipping company.

Only the consignee (person or company) can claim for these damages.

ita

INTRODUZIONE

Vi ringraziamo per l'utilizzo di SLIMBAR FLAT / SLIMBAR PLUS, la nostra LED LINEAR BAR ultra compatta con protezione IP67. Questa serie di LED linear bar è adatta per l'illuminazione d'accento.

Disponibile in due sorgenti di luce:

- RGBW con LEDs RGBW ad alta efficienza
- MONOCROMATICA o WHITE BALANCE con LEDs monocromatici ad alta efficienza

Disponibile in 2 misure, 100 cm. e 50 cm. Finitura standard è colore grigio.

- Art. 171045-171042: SLIMBAR FLAT/RGBW
- Art. 171215-171212: SLIMBAR FLAT/WB (white balance)
- Art. 171115-171112: SLIMBAR FLAT/M (monocromatico)
- Art. 201215-201212: SLIMBAR PLUS/RGBW (si differenzia da Slimbar Flat per l'uso delle ottiche)
- Art. 201615-201612: SLIMBAR PLUS/WB (si differenzia da Slimbar Flat per l'uso delle ottiche)
- Art. 201415-201412: SLIMBAR PLUS/W (si differenzia da Slimbar Flat per l'uso delle ottiche)

Per ottenere il meglio delle prestazioni ed un corretto funzionamento negli anni di questa unità, Vi consigliamo di leggere attentamente questo manuale prima di collegarla e metterla in uso. In questo modo acquisirete familiarità con i suoi comandi e collegamenti affinché possiate facilmente utilizzarla.

VOSTRA REFERENZA

Citate il numero del modello e di serie ogni volta che Vi rivolgete al vostro rivenditore per informazioni o assistenza.

CONFEZIONE BASE

- Proiettore
- Manuale d'uso
- Dichiarazione CE
- Garanzia Studio Due



Controllate che l'apparecchio non abbia subito alcun danno durante il trasporto.
 Se avesse subito dei danni o se non dovesse funzionare, rivolgetevi al vostro rivenditore.
 Se l'apparecchio vi è stato spedito direttamente, rivolgetevi subito alla ditta di trasporto.
 Solo il destinatario (la persona o ditta ricevente l'apparecchio) può reclamare per questo tipo di danni.

SLIMBAR PLUS TECHNICAL FEATURES / CARATTERISTICHE TECNICHE



- **SOURCE**
28 RGB-NW (white 4000K) LEDs (n.14 for 50cm.)
Lumen: R 460, G 950, B 260, CW 1000 (R 230, G 475, B 130, CW 500 for 50cm.)
Total light power: 32W (16W for 50cm.)
- **OPTIC**
24° (23mm lenses) PMMA 8N and ultra white tempered glass
On request: 12°, 36°, 10°x30°, 15°x55°, holographic filter 10°x80° to match with narrow beam
- **TILT**
Manual 200°
- **CONTROL**
n.4 Channels 48VDC
- **CONNECTIONS**
n.2 connectors 5pin IP 67 (male-female) cable 40cm.
possibility to link up to 5 devices in chain
- **SETUP AND CONFIGURATION**
To drive SLIMBAR PILOT RGBW use SLIMBAR-F Pilot
- **IP 67 RATING PROTECTION**
- **POWER CONSUMPTION**
36W (18W for 50cm.)
- **POWER SUPPLY**
48VDC - this fixture has to work with SLIMBAR-F Pilot
- **PHYSICAL**
WxDxH: 1005x40x60 mm (dimension of profile)
WxDxH: 525x40x60 mm (dimension of profile)
Weight: 1 Kg. or 0,5 Kg.



This fixture can only work connected to the dedicated DMX driver:
SLIMBAR PILOT-F DRS or SLIMBAR PILOT-F PLUS.

Questo apparecchio funziona solo collegato ad un driver DMX dedicato:
SLIMBAR PILOT-F DRS or SLIMBAR PILOT-F PLUS.



- **SOURCE**
n.30 LED NICHIA NVSLE21AT (4000K) (n.15 for 50cm.)
Total out lumen: 1800lm (900lm for 50cm.)
Total light power: 12W (6W for 50cm.)
- **OPTIC**
24° (23mm lenses) PMMA 8N and ultra white tempered glass
On request: 12°, 36°, 10°x30°, 15°x55°, holographic filter 10°x80° to match with narrow beam
- **TILT**
Manual 200°
- **CONTROL**
Constant Voltage 48VDC
- **CONNECTIONS**
n.2 connectors 5pin IP 67 (male-female) cable 40cm.
possibility to link up to 10 devices in chain
- **SETUP AND CONFIGURATION**
To drive SLIMBAR/W use SLIMBAR Pilot
- **IP 67 RATING PROTECTION**
- **POWER SUPPLY** (the fixture has to work with SLIMBAR Pilot)
13W (7W for 50cm.)
- **PHYSICAL**
WxDxH: 1005x40x60 mm (dimension of profile)
WxDxH: 525x40x60 mm (dimension of profile)
Weight: 1 Kg. or 0,5 Kg.



This fixture must be connected to the dedicated DMX driver: **SLIMBAR PILOT-F DRS or SLIMBAR PILOT-F PLUS.**
A voltage with an higher tolerance than specified may cause malfunction or damage.

L'apparecchio deve essere collegato ad un driver DMX dedicato: **SLIMBAR PILOT-F DRS or SLIMBAR PILOT-F PLUS.**
Una tensione di alimentazione con tolleranza maggiore di quella indicata può causare malfunzionamenti e danneggiare irreparabilmente l'apparecchio.



- **SOURCE**
n. 28x4 Red, Green, Blue, White mid power LEDs (n.14x4 for 50cm.)
Lumen: R 460, G 950, B 260, CW 1300 (R 230, G 475, B 130, CW 650 for 50cm.)
Total light power: 32W (16W for 50cm.)
- **OPTIC**
- 120° no lenses
- optional: milky diffuser
- **TILT**
Manual 160°
- **CONTROL**
n.4 Channels 52VDC
- **CONNECTIONS**
n.2 connectors 5pin IP 67 (male-female) cable 40cm.
possibility to link up to 5 devices in chain
- **SETUP AND CONFIGURATION**
To drive SLIMBAR FLAT use SLIMBAR-F Pilot
- **IP 67 RATING PROTECTION**
- **POWER CONSUMPTION**
42W (21W for 50cm.)
- **POWER SUPPLY**
52VDC - this fixture has to work with SLIMBAR-F Pilot
- **PHYSICAL**
WxDxH: 1000x35x40 mm (dimension of profile)
WxDxH: 500x35x40 mm (dimension of profile)
Weight: 1 Kg. or 0,5 Kg.



This fixture can only work connected to the dedicated DMX driver: SLIMBAR PILOT-F DRS or SLIMBAR PILOT-F PLUS.

Questo apparecchio funziona solo collegato ad un driver DMX dedicato: SLIMBAR PILOT-F DRS or SLIMBAR PILOT-F PLUS.



- **SOURCE (monochromatic)**
n. 112 warm, neutral or cool White LEDs (n.56 for 50cm.)
on request: red, blue, green or amber LEDs
Lumen: 5000 (2500 for 50cm.)
Total light power: 35W (17W for 50cm.)
- **OPTIC**
- 120° no lenses
- optional: milky diffuser
- **TILT**
Manual 160°
- **CONTROL**
n.4 Channels 48-52VDC
- **CONNECTIONS**
n.2 connectors 5pin IP 67 (male-female) cable 40cm.
possibility to link up to 5 devices in chain
- **SETUP AND CONFIGURATION**
To drive SLIMBAR FLAT use SLIMBAR-F Pilot
- **IP 67 RATING PROTECTION**
- **POWER CONSUMPTION**
42W (21W for 50cm.)
- **POWER SUPPLY**
52VDC - this fixture has to work with SLIMBAR-F Pilot
- **PHYSICAL**
WxDxH: 1000x35x40 mm (dimension of profile)
WxDxH: 500x35x40 mm (dimension of profile)
Weight: 1 Kg. or 0,5 Kg.

- **SOURCE (white balance)**
n. 56 (2700K) + 56 (6500K) White LEDs (n.28 + n.28 for 50cm.)
Lumen: 2300 + 2600 (1150 + 1300 for 50cm.)
Total light power: 35W (17W for 50cm.)



This fixture must be connected to the dedicated DMX driver: SLIMBAR PILOT-F DRS or SLIMBAR PILOT-F PLUS.
A voltage with an higher tolerance than specified may cause malfunction or damage.

L'apparecchio deve essere collegato ad un driver DMX dedicato: SLIMBAR PILOT-F DRS or SLIMBAR PILOT-F PLUS.
Una tensione di alimentazione con tolleranza maggiore di quella indicata può causare malfunzionamenti e danneggiare irreparabilmente l'apparecchio.



IMPORTANT



IMPORTANTE

THE EQUIPMENT IS SUPPLIED WITH A POWER-IN AND A POWER-OUT CONNECTORS WITH CABLE 40CM. LONG. DO NOT CUT THE CABLES, USE THE SUPPLIED CONNECTORS FOR EXTENSIONS.

L'APPARECCHIO È FORNITO DI UN CAVO LUNGO 40CM. CON CONNETTORE POWER-IN E DI UNO POWER-OUT. NON TAGLIARE I CAVI, UTILIZZARE I CONNETTORI IN DOTAZIONE PER I PROLUNGAMENTI.

CONNECTIONS / CONNESSIONI

eng

The SLIMBAR PILOT-F must be earthed.

Class I equipment. The power supply cord includes a protective earthing conductor as part of the cord.

IMPORTANT: to ensure the IP67 protection rating, in case of replacement of the conductor cable, refer to the CONDUCTOR SIZE TABLE

ita

SLIMBAR PILOT-F necessita di messa a terra.

Apparecchio di Classe I. Il conduttore di protezione deve far parte del cavo di alimentazione.

IMPORTANTE: per garantire il grado di protezione IP67, in caso di sostituzione del cavo di alimentazione, fare riferimento alla TABELLA SEZIONE CONDUTTORE.

EXAMPLE OF MAIN POWER or DMX CONNECTION

 **WARNING**

 **IMPORTANTE**

MAIN POWER/ INGRESSO ALIMENTAZIONE Ø 6 - 12mm	
CONDUCTOR SIZES / SEZIONE CONDUTTORE (length / lunghezza < 20mt.)	
MAINS VOLTAGE	CROSS SELECTIONAL AREAS
230V	3X1 mm ² (minimum)

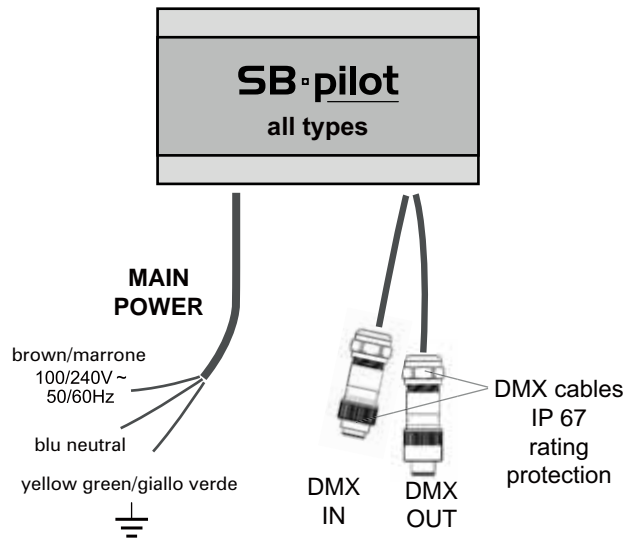
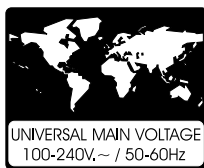

DMX TERMINAL LINE

The wrong connection of the terminal line or its non-connection are probably the most frequent reasons for the defective functioning of the DMX line. The terminator is a terminal resistor fitted at the end of the cable furthest from the transmitter.

The terminal resistor should have the same value as the impedance of the connection cable.

We suggest to use a terminal with a 120 Ohm resistor.

It is recommended that all DMX 512 systems have the terminal resistor fitted in the DMX output of the last fixture.

TERMINALE LINEA DMX

L'incorretto o il mancato collegamento del terminale di linea è probabilmente la più comune causa del difettoso funzionamento della linea DMX. Il terminale di linea DMX consiste in una resistenza posta alla fine della linea.

La resistenza terminale dovrebbe avere idealmente lo stesso valore dell'impedenza del cavo di collegamento.

Noi consigliamo di usare come terminale una resistenza da 120 Ohm.

E' raccomandato per tutti i sistemi DMX 512 inserire il terminale di linea nel connettore uscita DMX dell'ultimo apparecchio collegato.

4 PIN and XRL CONNECTORS / CONNETTORI 4 PIN e XRL

4 PIN connectors

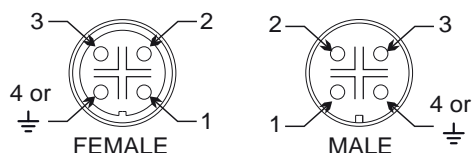

PIN	SIGNAL
1	GROUND/RETURN/OV
2	N.C.
3	DATA COMPLEMENT (-, INVERTED)
4 or \perp	DATA TRUE (+, NON INVERTED)

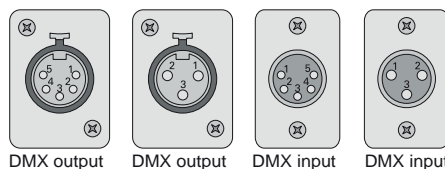

PIN	WIRE	SIGNAL
1	SHIELD	GROUND/RETURN/OV
2	INNER CONDUCTOR	DATA COMPLEMENT (-, INVERTED)
3	INNER CONDUCTOR	DATA TRUE (+, NON INVERTED)

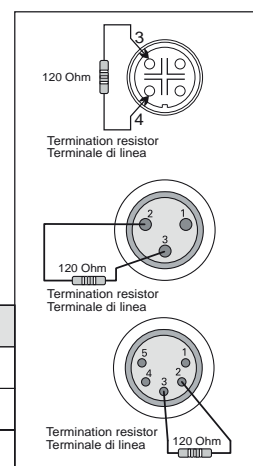

eng

The DRS it's a new concept of professional LED Lighting fixtures suitable for outdoor permanent installations. The LED Lighting fixtures can be driven via DMX through a specific electronic device, the DRS DMX Remote Setup, that grant the possibility to set up the scenarios and the games remotely. These LED Lighting fixtures have installed on board a series of programs including the stand alone function.

The DRS is a simple set up commander that linked with the DMX input of a LED Lighting fixture allow to program all the functions of the luminaire.

It's than possible to assign the DMX channel or use the Master/Slave function.

The device is powered through battery.

ita

DRS è il nuovo concetto dell'illuminazione LED per uso professionale nelle installazioni esterne permanenti.

Gli apparecchi LED possono essere controllati e configurati tramite uno specifico controller: il DRS, DMX Remote Setup, il quale consente di programmare e configurare scene e giochi di luce in modalità remota.

Questi apparecchi LED hanno installati a bordo una serie di giochi che includono la funzione stand alone.

Il DRS, DMX Remote Setup, è un semplice set-up commander che collegato via DMX ad un'apparecchio consente la sua programmazione e configurazione.





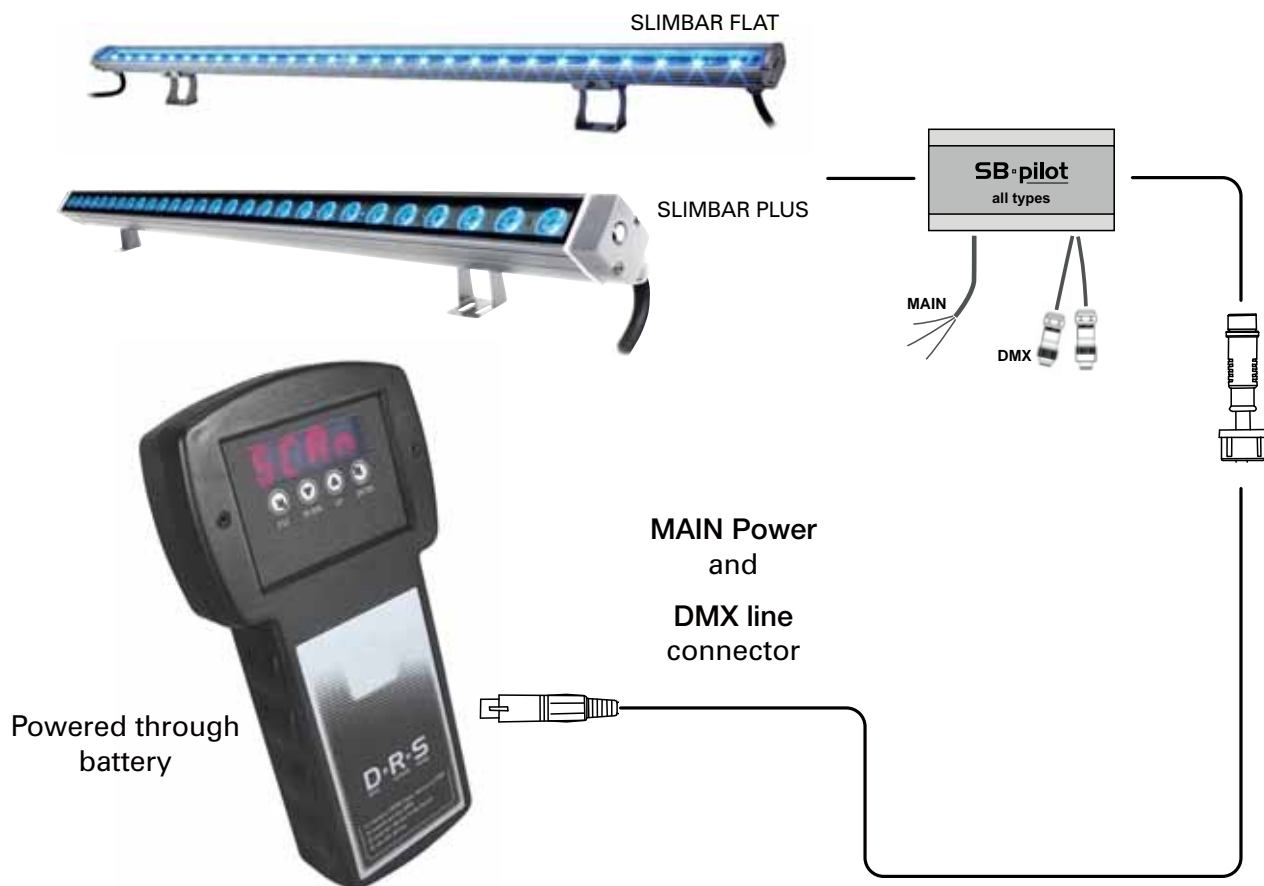

E' possibile assegnare agli apparecchi collegati i canali DMX o utilizzzare la funzione Master/Slave.

Il DRS è alimentato a batterie.



DRS (DMX Remote Setup) FUNCTIONING





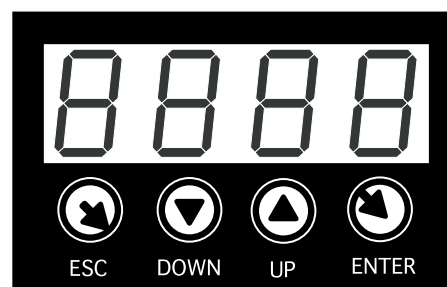

To make the set-up of the various fixture parameter, proceed as follow:

- Disconnect the fixture to set-up from the other DMX/RDM devices
- Connect the DMX cable of the fixture to the DRS commander
-  Switch on the DRS (push any button) commander and wait for the 8888 sign
-  If the DRS commander detects a compatible DRS device, displays shortly the **Conn** written and afterwards, displays the name of the fixture and its software version.
-  If the DRS commander don't detects any compatible DRS device or is present any malfunction, the display shows the **SCAn** written
-  When the detection sequence is finished, the display shows the first menu
-  The UP/DOWN buttons allow to scroll forward/backward the menu list
-  The ENTER button allow to confirm the selected option (if the parameter is flashing)
-  The ESC button allow to delete the operation and return to a previous menu level



FUNZIONAMENTO DI BASE DEL DRS (DMX Remote Setup)

Per effettuare la programmazione dei vari parametri di un apparecchio, è necessario procedere come segue:











- Disconnettere l'apparecchio da configurare da altri dispositivi DMX/RDM
- Collegare il cavo DMX dell'apparecchio da configurare, al programmatore DRS
-  Accendere il programmatore DRS (spingere uno dei pulsanti) ed attendere che visualizzi la scritta 8888
-  Se il programmatore DRS individua un dispositivo DRS compatibile, visualizza per qualche istante la scritta **Conn** e, successivamente, visualizza il nome dell'apparecchio e la relativa versione software
-  Se il programmatore DRS non individua alcun dispositivo DRS compatibile o è presente qualche malfunzionamento il display visualizzerà la scritta **SCAn**
-  Una volta terminata la sequenza di riconoscimento, viene visualizzato il primo menu dell'apparecchio
-  I pulsanti UP/DOWN permettono di scorrere la lista dei menu
-  Il pulsante ENTER permettere di entrare in un menu o di confermare una opzione in caso di lampeggio del parametro
-  Il pulsante ESC annulla una operazione o torna al livello di menu inferiore.

SLIMBAR DRS MENU' LIST ELENCO MENU' SLIMBAR DRS

Switching on the fixture you can see the model and the software version. For example:

All'accensione, viene visualizzato il modello di apparecchio e la versione software. Per esempio:

--> Slimbar rGbW --> 2_00
than it's shown the fist menu
poi viene visualizzato il primo menu

Address (Addr)		Set the DMX address Imposta l'indirizzo DMX
Auto Mode (ModE)		Set the DMX, SLAVE or MASTER mode Imposta la modalità DMX, SLAVE o MASTER (no, SL, Pr01...Prxx)
Auto Speed (PrSP)		Set the preset execution speed Imposta la velocità di esecuzione dei giochi interni (-400%...+400%)
Wireless enable (ULEn)		Enable or disable the wireless reception Consente o non consente la ricezione wireless (ON / OFF) The cable reception is disabled / La ricezione via cavo viene disabilita
Wireless unlink (ULPA)		Remove the link from the fixture to the associated transmitter (PA?) Elimina il link tra l'apparecchio e il trasmettitore al quale è stato associato
Smooth Dimming (SMth)		Set the interpolation type for the smooth dimming function Imposta il tipo di interpolazione per la funzione smooth dimming (OFF, Sd1, Sd2, Sd3)
Halogen Simulation (HALS)		Set the halogen simulation function mode Imposta il funzionamento della modalità simulazione lampada alogena (OFF, Mod1, Mod2)
Flicker free function (FLcr)		Select the value f1 .. f2 Selezionate il valore desiderato f1 .. f2
Test (tEst)		Enables the test of the fixture and execute a factory program to check the right functioning Abilita il test dell'apparecchio ed esegue un programma di fabbrica per verificarne il funzionamento (OFF, On)
Reset (rSEt)		Execute a reset of the electronic section Esegue un reset della parte elettronica
Format (FrMt)		Restore the factory setting (Require confirmation) Ripristina le impostazioni di fabbrica (Viene chiesta conferma)

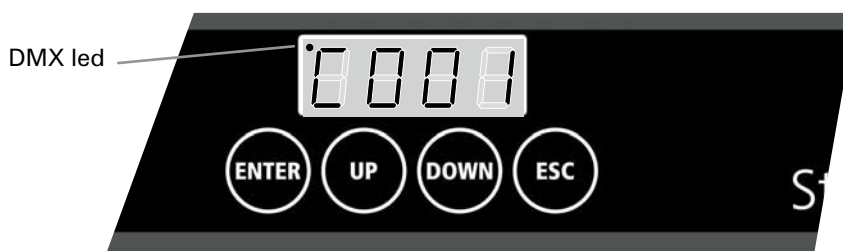

If you want to enter into setup mode, you must follow the start procedure:
 Se desiderate entrare nella modalità setup, dovete seguire la procedura di accesso:
 Press keys in sequence / Premere i tasti in sequenza:

ENTER >> UP >> DOWN >> ESC

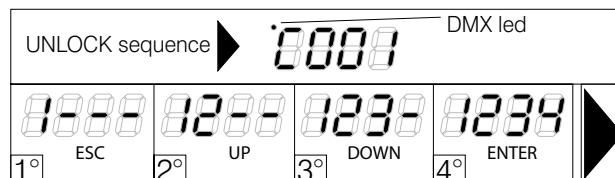

Switching on the fixture you can see the model and the software version. For example:
 All'accensione, viene visualizzato il modello di apparecchio e la versione software. Per esempio:

--> Studio Due Slimbar --> 1_1 0 --> DMX channel --> C001
 than it's shown the first DMX channel. When you press any button it's shown the first menu.
 poi viene visualizzato il primo canale DMX. Quando si preme qualsiasi pulsante, viene visualizzato il primo menu.

- **ENTER:** enter into the menu/submenu (if present) / entra nel menu/sottomenu (se presente)
- **UP:** scroll up into the menu / scorre in alto nel menu
- **DOWN:** scroll down into the menu / scorre in basso nel menu
- **ESC:** exit from the menu/submenu / esce dal menu/sottomenu

When the display flashing you always must press and hold 1 sec. ENTER to confirm the selected option.
 Quando il display lampeggia dovete sempre tenere premuto per 1 sec. ENTER per confermare l'opzione scelta.

menu Address (Addr) > Set the DMX address / Imposta l'indirizzo DMX

press ENTER / premere ENTER

↳

- > Select the channel number .. c001 .. c002 .. whit the UP/DOWN buttons. Press ENTER.
- > Selezionate il canale desiderato .. c001 .. c002 .. con i tasti UP/DOWN. Premere ENTER.

menu Display (dISP) > Display functions / Funzioni del display

press ENTER for submenu / premere ENTER per i sottomenu

↳ (FLIP) 180° display rotate / Ruota di 180° il display

- > Select the value off .. on whit the UP/DOWN buttons. Press ENTER.
- > Selezionate il valore desiderato off .. on con i tasti UP/DOWN. Premere ENTER.

↳ (brGt) Display brightness settings / Impostazioni luminosità del display

- > Select the value 1 .. 7 whit the UP/DOWN buttons. Press ENTER.
- > Selezionate il valore desiderato 1 .. 7 con i tasti UP/DOWN. Premere ENTER.

↳ (LdMn) Display dimmer (with active menu) / Dimmer del display (con menu attivo)

- > Select the value off .. on whit the UP/DOWN buttons. Press ENTER.
- > Selezionate il valore desiderato off .. on con i tasti UP/DOWN. Premere ENTER.



press ENTER for submenu / premere ENTER per i sottomenu

→ (Mode)
Set the DMX/SLAVE/MASTER mode / Imposta la modalità DMX/SLAVE/MASTER

- > Select the value no .. sl .. pr01 .. pr02 .. with the UP/DOWN buttons. Press ENTER.
- > Selezionate il valore desiderato no .. sl .. pr01 .. pr02 .. con i tasti UP/DOWN. Premere ENTER.

→ (SPd)
Set the preset execution speed / Imposta la velocità di esecuzione dei giochi interni

- > Select the value +400% .. -400% with the UP/DOWN buttons. Press ENTER.
- > Selezionate il valore desiderato +400% .. -400% con i tasti UP/DOWN. Premere ENTER.

→ (ScnE)
Enable or disable the use of a personal scene / Abilia o disabilita l'uso di una scena personale.

- > Select the value ON .. OFF with the UP/DOWN buttons. Press ENTER.
- > Selezionate il valore desiderato ON .. OFF con i tasti UP/DOWN. Premere ENTER.

If menu SCENE (ScnE) is enabled, it is possible to create a personal scene (you can create a custom color utilizing the menu which will appear below > RED, GREEN, BLUE, WHITE, WHITE BALANCE, varying the DMX values from 0 to 255 for each color)

Se il menu SCENE (ScnE) è attivo, è possibile creare una scena personale (potete creare un colore personalizzato utilizzando i menu che appariranno di seguito > RED, GREEN, BLUE, WHITE, WHITE BALANCE, variando i valori DMX da 0 a 255 per ogni colore)

→ red
For each color or menu it is possible to varying and than set-up the value from 0 to 255 without having to confirm with the ENTER key. These functions are auto-save.

green
Per ogni singolo colore o menu, è possibile variare e quindi impostare il valore da 0 a 255 senza dover confermare con il tasto ENTER. Queste funzioni si salvano automaticamente.

blue
> Select the single color with the UP/DOWN buttons. Press ENTER.
> Selezionate il colore con i tasti UP/DOWN. Premere ENTER.

white (not used)
> Select the value 0 .. 255 with the UP/DOWN buttons. Don't press ENTER.
> Selezionate il valore desiderato 0 .. 255 con i tasti UP/DOWN. Non premere ENTER.

white balance (not used)

menu Wireless (WLSS) > Wireless functions / Funzioni wireless

0099 press ENTER for submenu / premere ENTER per i sottomenu

↳ E A A B (EnAb) Enable wireless
Enable or disable the wireless reception / Consente o non consente la ricezione wireless
The cable reception is disabled / La ricezione via cavo viene disabilitata

- > Select the value on .. off .. with the UP/DOWN buttons. When the written is flashing, press ENTER.
- > Selezionate il valore desiderato on .. off .. con i tasti UP/DOWN. Quando la scritta lampeggia, premere ENTER.

↳ 0 A L A (UnLn) Unlink transmission
Remove the link from the fixture to the associated transmitter / Elimina il link tra l'apparecchio e il trasmettitore al quale è stato associato

- > Select the value on .. off .. with the UP/DOWN buttons. When the written is flashing, press ENTER.
- > Selezionate il valore desiderato on .. off .. con i tasti UP/DOWN. Quando la scritta lampeggia, premere ENTER.

menu Utility (UtlL) > Utility functions / Funzioni di utilità

0011 press ENTER for submenu / premere ENTER per i sottomenu

↳ 5 0 2 4 (SMth)
Set the interpolation type for the smooth dimming function
Imposta il tipo di interpolazione per la funzione smooth dimming

- > Select the value off .. LoW .. Mid .. hIGH with the UP/DOWN buttons. Press ENTER.
- > Selezionate il valore desiderato off .. LoW .. Mid .. hIGH con i tasti UP/DOWN. Premere ENTER.

↳ A A L 0 (hALo)
Set the alogen simulation function mode
Imposta il funzionamento della modalità simulazione lampada alogena

- > Select the value off .. Mid1 .. Mid2 with the UP/DOWN buttons. Press ENTER.
- > Selezionate il valore desiderato off .. Mid1 .. Mid2 con i tasti UP/DOWN. Premere ENTER.

↳ P - H E (P-ht)
Simulation of the pre-heating of the halogen lamp
Simulazione del pre riscaldamento della lampada alogena

- > Select the value off >> pre-heating off --- on >> pre-heating on (with the UP/DOWN buttons). Press ENTER.
- > Selezionate il valore desiderato off >> preriscaldamento off ---- on >> pre-heating on (con i tasti UP/DOWN). Premere ENTER.



press ENTER for submenu / premere ENTER per i sottomenu



(FrMt)

Restore the factory setting (Require confirmation) **FM-?**

Ripristina le impostazioni di fabbrica (Viene chiesta conferma) **FM-?**

- > Select the value **off .. on** with the UP/DOWN buttons. Press ENTER.
- > Selezionate il valore desiderato **off .. on** con i tasti UP/DOWN. Premere ENTER.



(tEST)

Enables the fixture test and execute a factory program to check the right functioning.

Abilita il test dell'apparecchio ed esegue un programma di fabbrica per verificarne il funzionamento

- > Select the value **t-on** with the UP/DOWN buttons. T-on is flashing, the test is in progress. Press any key to exit.
- > Selezionate il valore desiderato **t-on** con i tasti UP/DOWN. T-on lampeggia, il test è in corso. Premere qualsiasi tasto per uscire.



(FLCr) Flicker free function / Funzione flicker free

from 2.09 software version / dalla versione software 2.09

EXAMPLE OF CONNECTION DMX CONTROLLER - FIXURES DRIVER/
ESEMPIO DI COLLEGAMENTO CENTRALINA - DRIVER APPARECCHI

Example 1/ Esempio 1

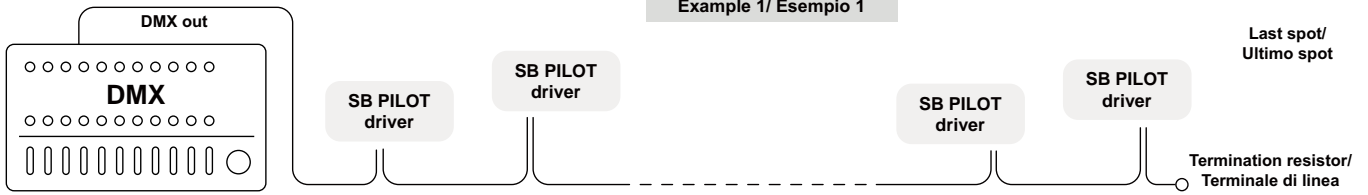

Example 2 / Esempio 2

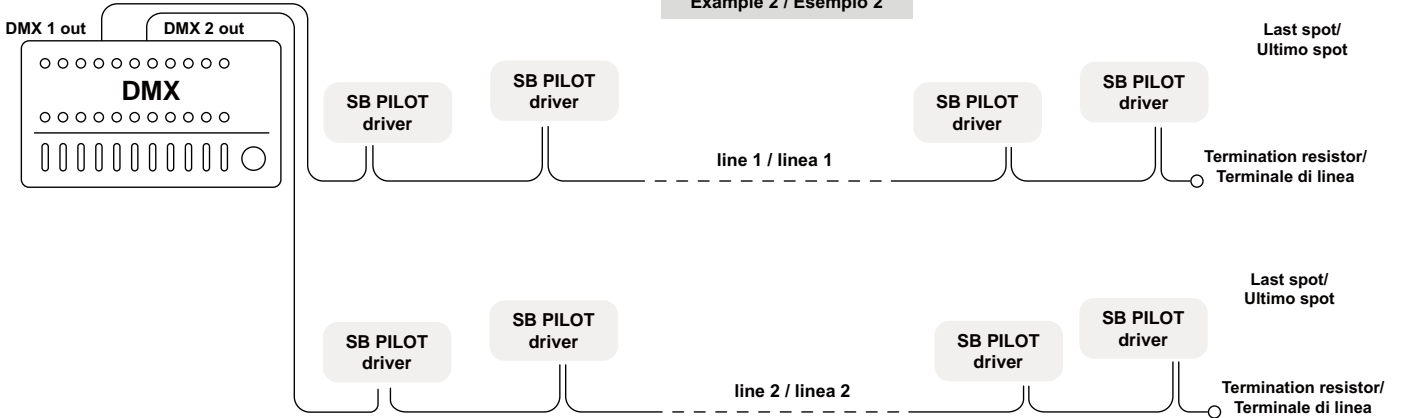

Example 3 / Esempio 3

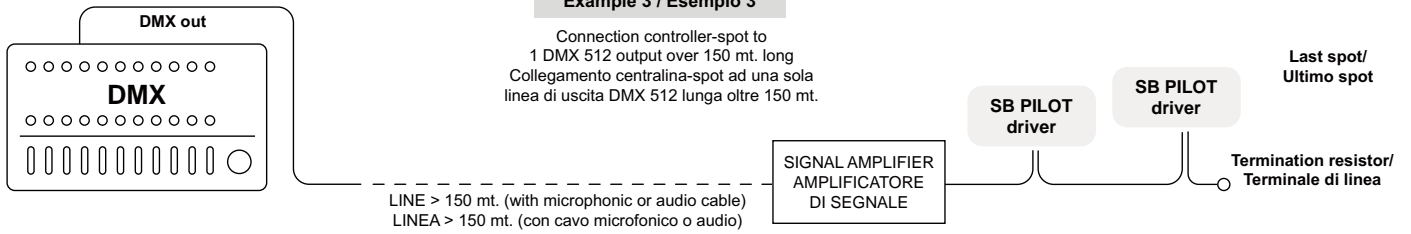

NORMAL AND MASTER/SLAVE FUNCTIONS / FUNZIONI NORMAL E MASTER/SLAVE

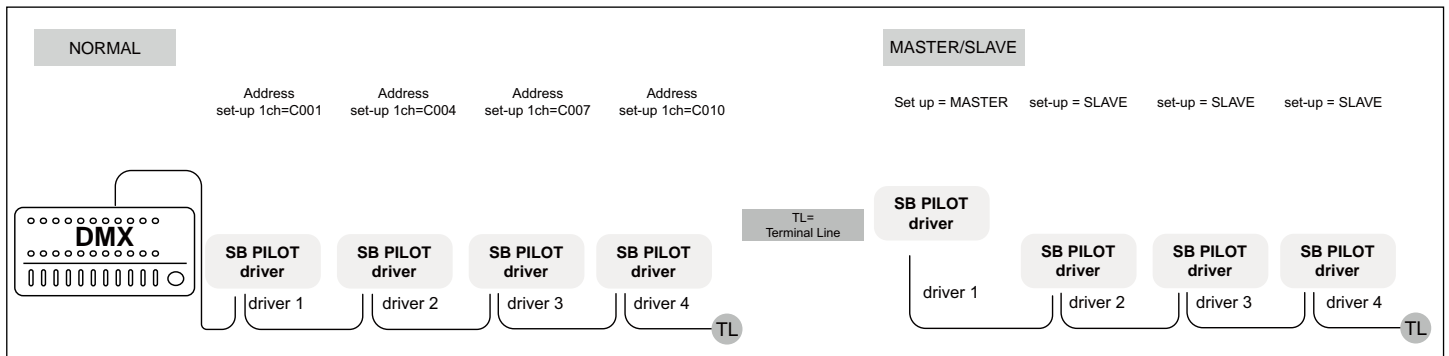

RGBW VERSION - SLIMBAR PLUS and SLIMBAR FLAT SLIMBAR PILOT (CONTROL DRIVE SOLUTIONS)

art. SB PILOT MAX RGBW

4 channels DMX Control Drive to control up to 8mt. of RGBW SLIMBAR PLUS or RGBW SLIMBAR FLAT. Version with control panel. IP 67 protection rating.

TECHNICAL FEATURES

- n.2x52V Constant Voltage output
- IP 67 rating protection
- N.2 out connectors (5 pin) for fast and easy wiring
- DISPLAY and touch pads set-up
- Flicker-free function
- Halogen simulation
- Smooth dimming function
- Voltage range: 100-240VAC Frequency range: 47-63Hz
- Max out Power: 320W - Max power consumption: 350W
- WxDxH: 390x150x85mm - Weight: 2.6 Kg.

example of RGBW connection

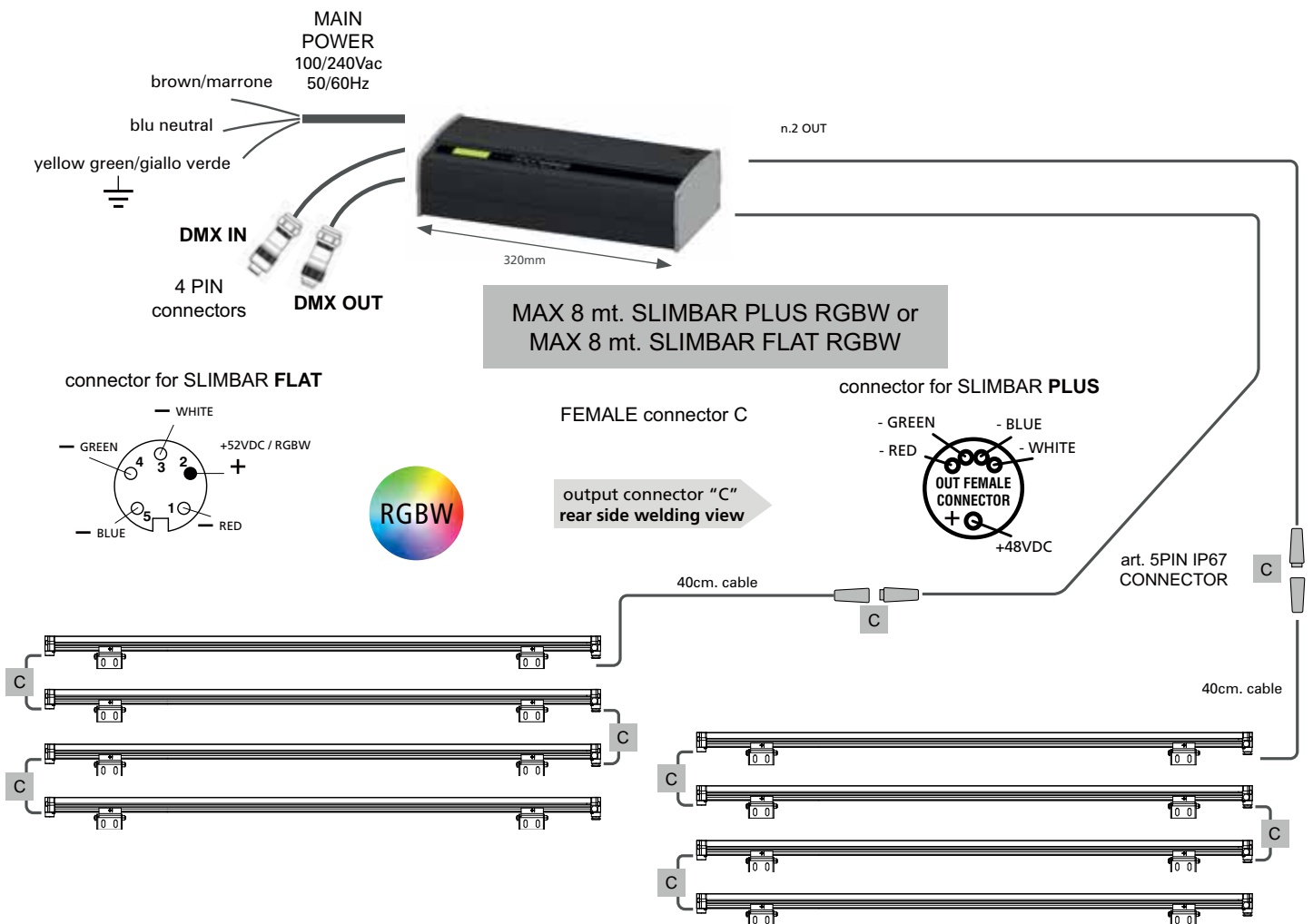

art. SB PILOT PLUS RGBW

1

4 channels DMX Control Drive to control up to 4mt. of RGBW SLIMBAR PLUS or RGBW SLIMBAR FLAT. Version **with control panel**. IP 67 protection rating.

TECHNICAL FEATURES

- n.2x52V Constant Voltage output
- IP 67 rating protection
- N.2 out connectors (5 pin) for fast and easy wiring
- DISPLAY and touch pads set-up**
- Flicker-free function
- Halogen simulation
- Smooth dimming function
- Voltage range: 100-240VAC Frequency range: 47-63Hz
- Max out Power: 140W
- Max power consumption: 150W
- WxDxH: 420x90x70mm - Weight: 2.5 Kg.

art. SB PILOT PLUS DRS RGBW

2

4 channels DMX Control Drive to control up to 4mt. of RGBW SLIMBAR PLUS or RGBW SLIMBAR FLAT. Version **without control panel**. IP 67 protection rating.

TECHNICAL FEATURES

- n.2x52V Constant Voltage output
- IP 67 rating protection
- N.2 out connectors (5 pin) for fast and easy wiring
- DMX DRS setup**
- Flicker-free function
- Halogen simulation
- Smooth dimming function
- Voltage range: 100-240VAC Frequency range: 47-63Hz
- Max out Power: 140W
- Max power consumption: 150W
- WxDxH: 420x90x70mm - Weight: 2.5 Kg.

example of RGBW connection

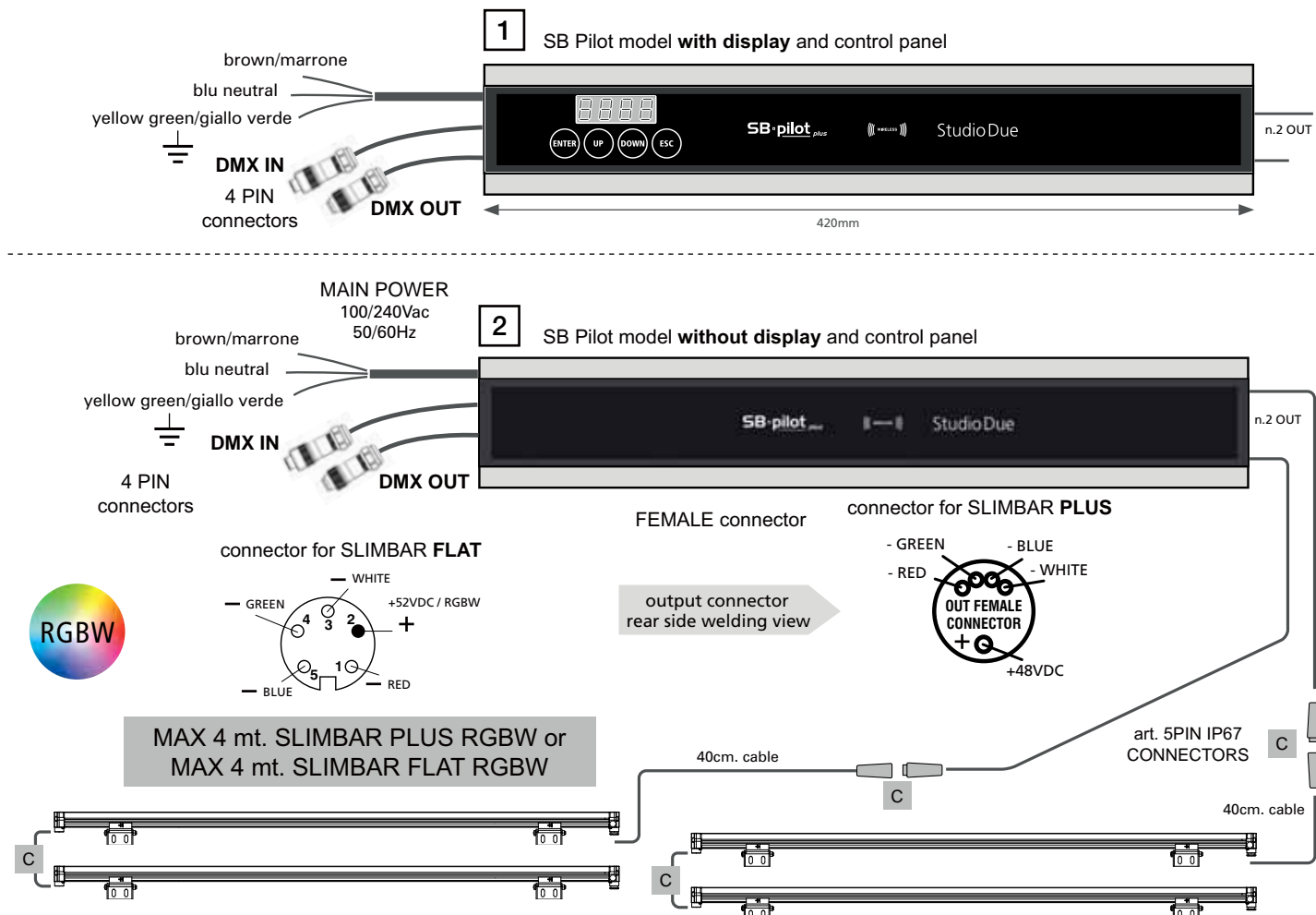

art. SB PILOT DRS RGBW

4 channels DMX Control Drive DRS to control up to 1mt. of RGBW SLIMBAR PLUS or RGBW SLIMBAR FLAT. IP 67 protection rating.

TECHNICAL FEATURES

- (constant voltage 52V)
- IP 67 rating protection
- n.1 out connectors (5 pin) for fast and easy wiring
- DMX DRS setup**
- DMX or Auto mode with Master-Slave function
- Halogen simulation
- Flicker-free function
- Smooth dimming function
- Voltage range: 100-240VAC Frequency range: 47-63Hz Max out Power: 60W
- Max power consumption: 70W
- WxDxH: 280x90x70mm
- Weight: 1.1 Kg.

example of RGBW connection

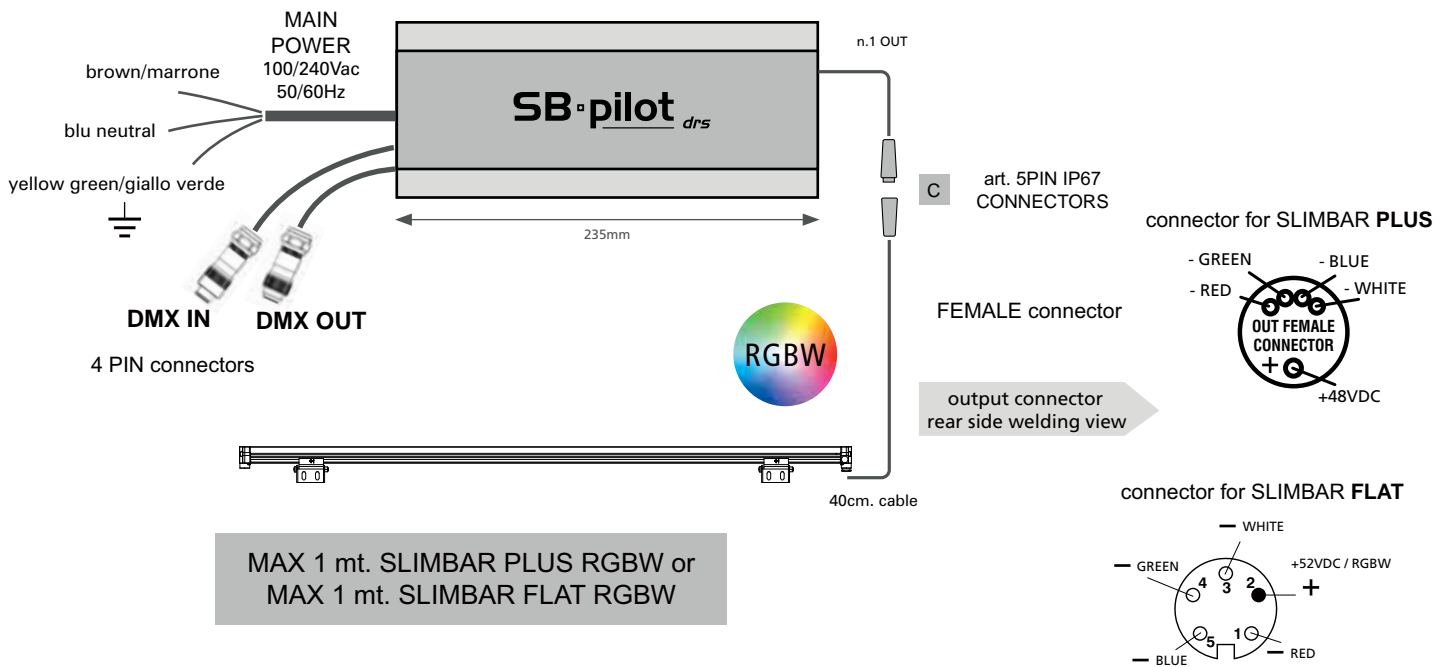

art. MD-BOX

Multichannels led driver, DMX constant voltage with n.10 independent outputs to control up to n.10 fixtures.

example of RGBW connection

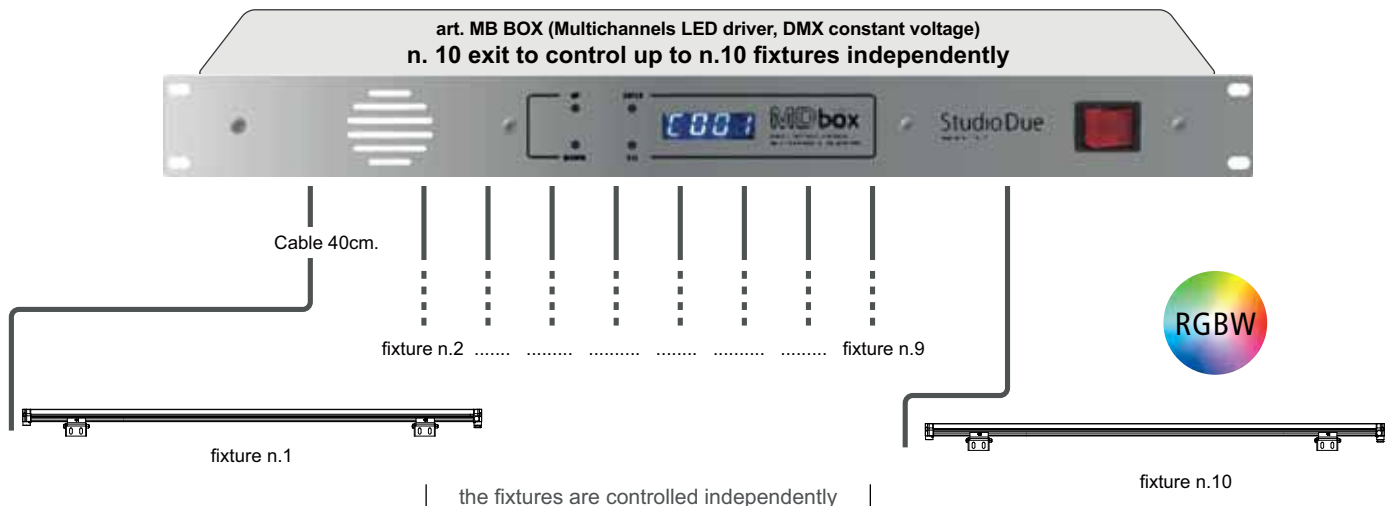

MONOCHROMATIC / WHITE BALANCE VERSION

SLIMBAR PLUS and SLIMBAR FLAT

SLIMBAR PILOT (CONTROL DRIVE SOLUTIONS)

art. SB PILOT MAX M	4 channels DMX Control Drive to control up to 16mt. of MONOCHROMATIC SLIMBAR PLUS or 8mt. of MONOCHROMATIC SLIMBAR FLAT. Version with control panel. IP 67 protection rating.
art. SB PILOT MAX M DALI	1 channel DALI Control Drive to control up to 16mt. of MONOCHROMATIC SLIMBAR PLUS or 8mt. of MONOCHROMATIC SLIMBAR FLAT. Without control panel. IP 67 protection rating.
art. SB PILOT MAX WB	2 channels DMX Control Drive to control up to 8mt. of WHITE BALANCE SLIMBAR FLAT. Version with control panel. IP 67 protection rating.

TECHNICAL FEATURES

- n.2x52V Constant Voltage output
- IP 67 rating protection
- N.2 out connectors (5 pin) for fast and easy wiring
- DISPLAY and touch pads set-up**
- Flicker-free function
- Halogen simulation
- Smooth dimming function
- Voltage range: 100-240VAC Frequency range: 47-63Hz
- Max out Power: 320W - Max power consumption: 350W
- WxDxH: 390x150x85mm - Weight: 2.6 Kg.

example of MONOCHROMATIC - WHITE BALANCE connection

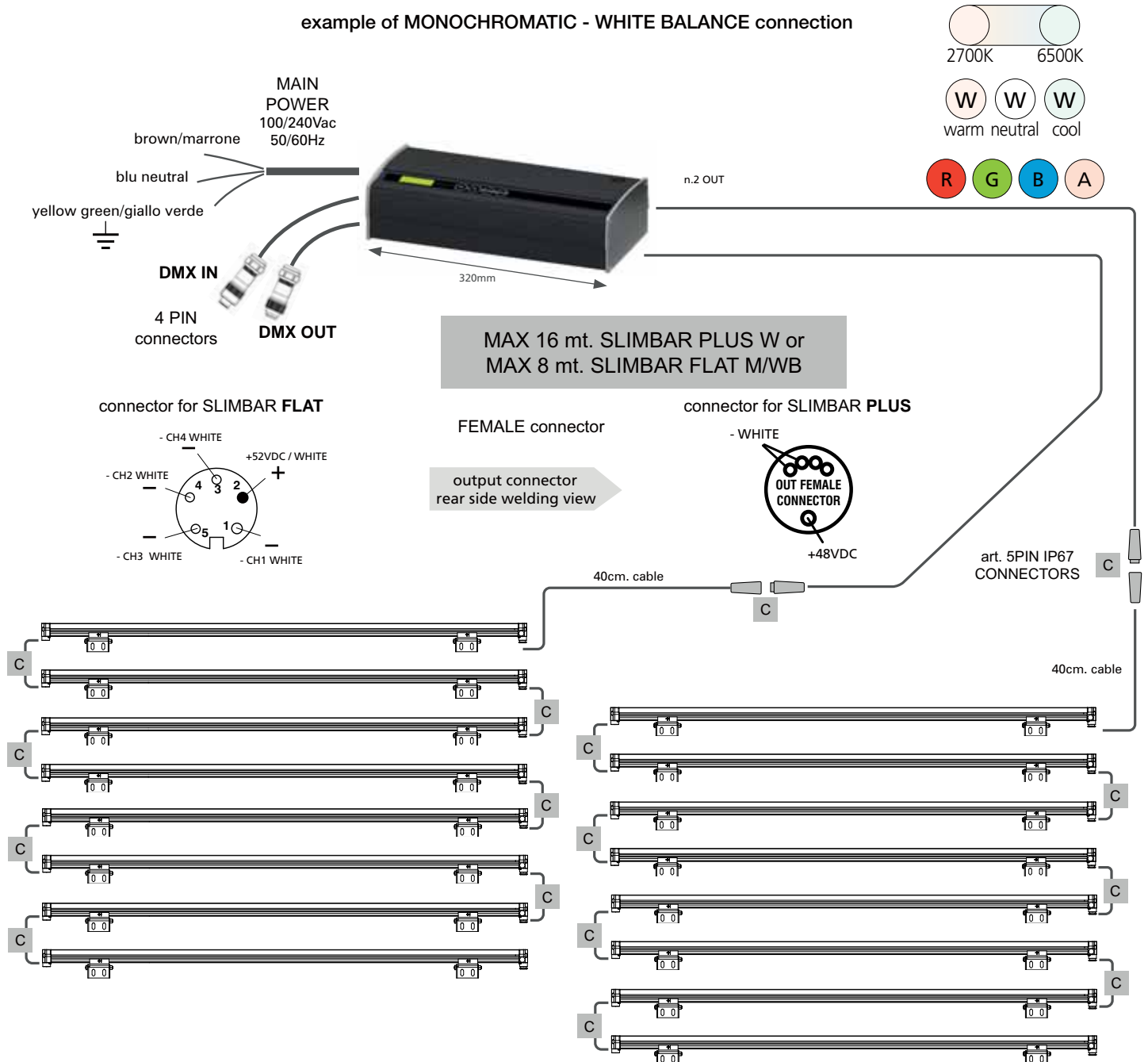

art. SB PILOT PLUS M	1	4 channels DMX Control Drive to control up to 9mt. of MONOCHROMATIC SLIMBAR PLUS or 3mt. of MONOCHROMATIC SLIMBAR FLAT. Version with control panel. IP 67 protection rating.
art. SB PILOT PLUS WB	1	2 channels DMX Control Drive to control up to 3mt. of WHITE BALANCE SLIMBAR FLAT. Version with control panel. IP 67 protection rating.
art. SB PILOT PLUS DRS M	2	4 channels DMX Control Drive DRS to control up to 9mt. of MONOCHROMATIC SLIMBAR PLUS or 3mt. of MONOCHROMATIC SLIMBAR FLAT. Without control panel. IP 67 protection rating.
art. SB PILOT PLUS M DALI	2	1 channel DALI Control Drive to control up to 9mt. of MONOCHROMATIC SLIMBAR PLUS or 3mt. of MONOCHROMATIC SLIMBAR FLAT. Without control panel. IP 67 protection rating.
art. SB PILOT PLUS DRS WB	2	2 channels DMX Control Drive DRS to control up to 3mt. of WHITE BALANCE SLIMBAR FLAT. Without control panel. IP 67 protection rating.

TECHNICAL FEATURES

n.2x52V Constant Voltage output
 IP 67 rating protection
 N.2 out connectors (5 pin) for fast and easy wiring
DISPLAY and touch pads set-up
 Flicker-free function
 Halogen simulation
 Smooth dimming function
 Voltage range: 100-240VAC Frequency range: 47-63Hz
 Max out Power: 140W - Max power consumption: 150W
 WxDxH: 420x90x70mm - Weight: 2.5 Kg.

TECHNICAL FEATURES

n.2x52V Constant Voltage output
 IP 67 rating protection
 N.2 out connectors (5 pin) for fast and easy wiring
DMX DRS setup
 Flicker-free function
 Halogen simulation
 Smooth dimming function
 Voltage range: 100-240VAC Frequency range: 47-63Hz
 Max out Power: 140W - Max power consumption: 150W
 WxDxH: 420x90x70mm - Weight: 2.5 Kg.

example of MONOCHROMATIC or WHITE BALANCE connection

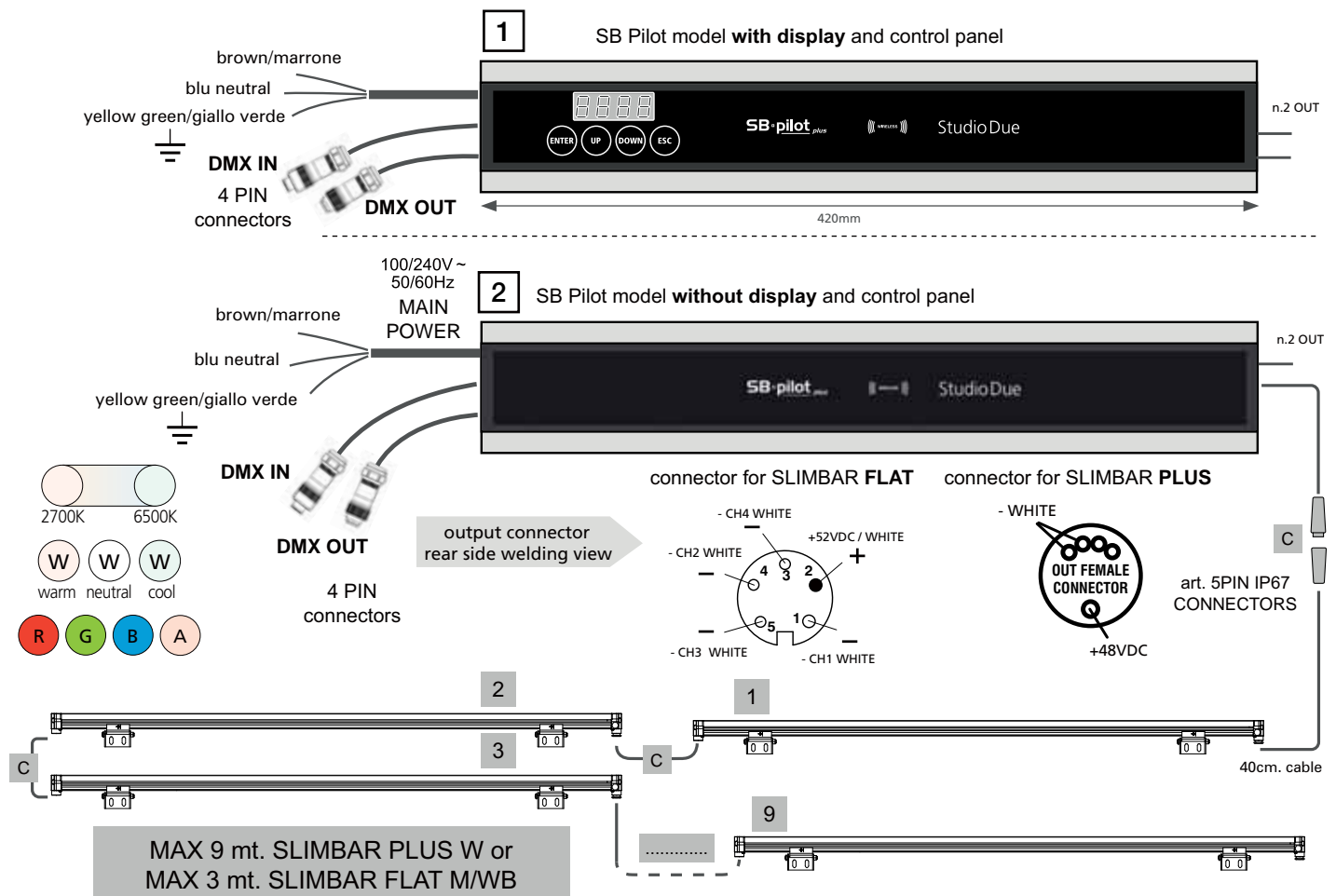

art. SB PILOT DRS M	4 channels DMX Control Drive DRS to control up to 3mt. of MONOCHROMATIC SLIMBAR PLUS or 1mt. of MONOCHROMATIC SLIMBAR FLAT. Without control panel. IP 67 protection rating.
art. SB PILOT M DALI	1 channel DALI Control Drive to control up to 3mt. of MONOCHROMATIC SLIMBAR PLUS or 1mt. of MONOCHROMATIC SLIMBAR FLAT. Without control panel. IP 67 protection rating.
art. SB PILOT DRS WB	2 channels DMX Control Drive DRS to control up to 1mt. of WHITE BALANCE SLIMBAR FLAT. Without control panel. IP 67 protection rating.

TECHNICAL FEATURES

(constant voltage 52V)
 IP 67 rating protection
 n.1 out connectors (5 pin) for fast and easy wiring
DMX DRS setup
 DMX or Auto mode with Master-Slave function
 Halogen simulation
 Flicker-free function
 Smooth dimming function
 Voltage range: 100-240VAC Frequency range: 47-63Hz Max out Power: 60W
 Max power consumption: 70W
 WxDxH: 280x90x70mm - Weight: 1.1 Kg.

example of MONOCHROMATIC or WHITE BALANCE connection

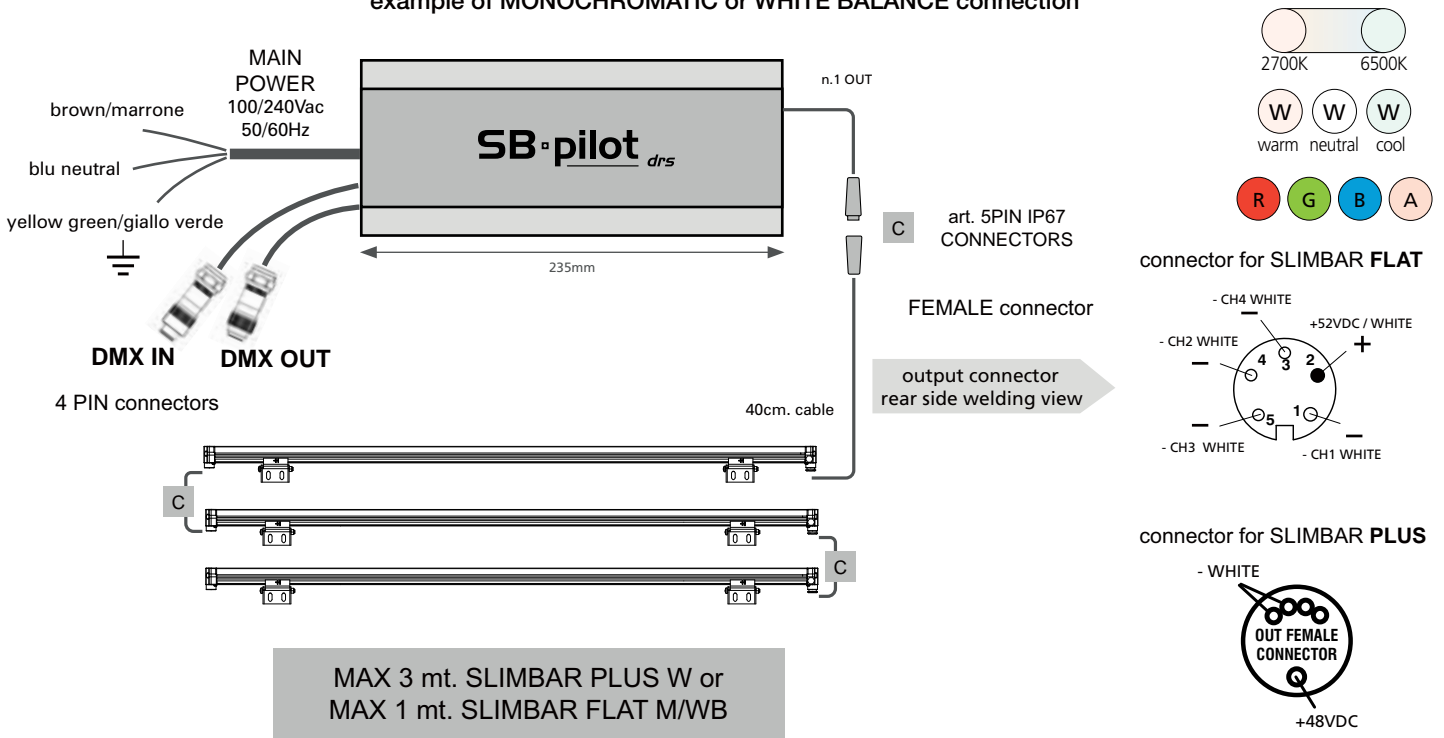

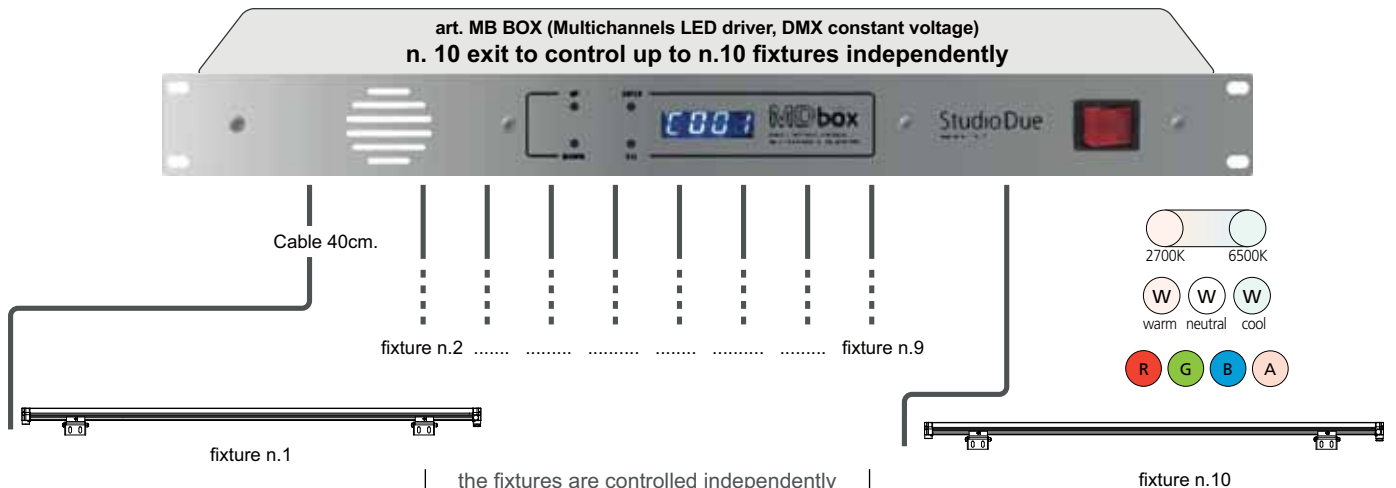

art. MD-BOX	Multichannels led driver, DMX constant voltage with n.10 independent outputs to control up to n.10 fixtures.
--------------------	--

example of MONOCHROMATIC connection





MONOCHROMATIC PLUG IN VERSION - SLIMBAR PLUS and SLIMBAR FLAT (POWER SUPPLY)

POWER SUPPLY IP67

	art. SB PS PLUG-IN 320 M	Power Supply to drive up to 16mt. of MONOCHROMATIC SLIMBAR PLUS or 7mt. of MONOCHROMATIC SLIMBAR FLAT. PLUG IN version. IP 67 protection rating. Length 250mm.
	art. SB PS PLUG-IN 150 M	Power Supply to drive up to 8mt. of MONOCHROMATIC SLIMBAR PLUS or 3mt. of MONOCHROMATIC SLIMBAR FLAT. PLUG IN version. IP 67 protection rating. Length 235mm.
	art. SB PS PLUG-IN 60 M	Power Supply to drive up to 3mt. of MONOCHROMATIC SLIMBAR PLUS or 1mt. of MONOCHROMATIC SLIMBAR FLAT. PLUG IN version. IP 67 protection rating. Length 180mm.

external POWER SUPPLY IP20

	art. SPS320-50 M	External Power Supply to drive up to 16mt. of MONOCHROMATIC SLIMBAR PLUS or 7mt. of MONOCHROMATIC SLIMBAR FLAT. IP 20 protection rating.
	art. SPS150-50 M	External Power Supply to drive up to 9mt. of MONOCHROMATIC SLIMBAR PLUS or 3mt. of MONOCHROMATIC SLIMBAR FLAT. IP 20 protection rating.
	art. SPS60-50 M	External Power Supply to drive up to 3mt. of MONOCHROMATIC SLIMBAR PLUS or 1mt. of MONOCHROMATIC SLIMBAR FLAT. IP 20 protection rating.

general example of MONOCHROMATIC PLUG IN connection

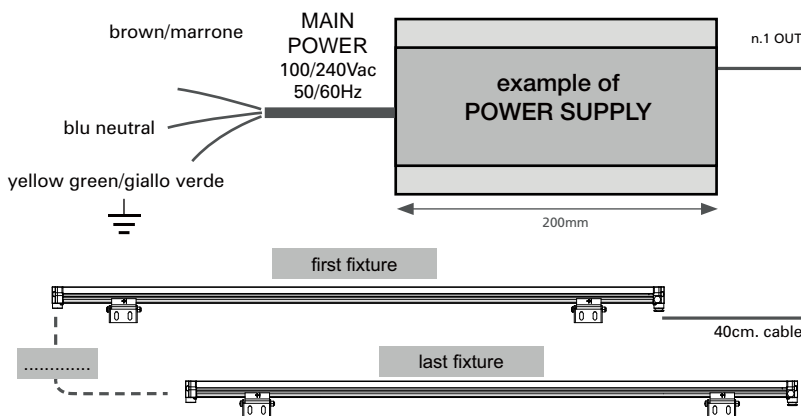

refer to the table above for the number of fixtures to be connected to power supplies

art. 5PIN IP67 CONNECTORS

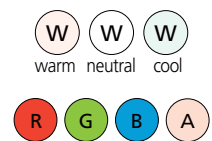

FEMALE connector

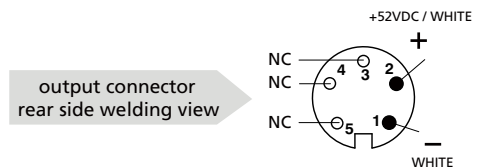

connector for SLIMBAR PLUS

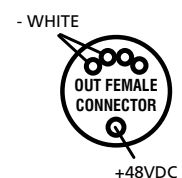

Warranty CARD

Company name:

Mr./Mrs./Miss:

Address:

Tel. or E-mail :

Dealer:

SALE CONDITIONS

1) Price quoted are not inclusive of lamp and package.

Package charge is 2% on the net price for all the items, except for art. 0403 (CS4), that is 4%.

These prices should be subject to possible variations for eventual rises of production costs or duties.

Claims for possible damages during the freight, must be notified to the carrier.

Any claim must be notified within 8 days from the receipt of the goods.

The buyer is responsible of the right installation and use of the apparatus.

All the apparatuses are guaranteed for one year against defects of manufacture or materials.

Defects and breakages caused by wrong connection or use of the apparatuses are not subject to guarantee.

The lamp is excluded from the warranty.

For any dispute is competent the Tribunal of Viterbo.

CONDIZIONI DI VENDITA

1) I prezzi riportati sono esclusi di IVA, lampada ed imballaggio.

Il costo di imballaggio è del 2% sul prezzo netto per tutti gli articoli, eccetto per l'art. 0403 (CS4) che è del 4%.

Detti prezzi possono essere soggetti a possibili variazioni per eventuali aumenti dei costi di produzione o imposte.

La merce viaggia a rischio e pericolo del committente, anche se in porto franco.

Reclami per possibili danni durante il trasporto, dovranno essere fatti esclusivamente al vettore.

Eventuali osservazioni sulle merci ricevute dovranno esserci notificate entro e non oltre 8 giorni dal ricevimento delle medesime.

Sui ritardi dei pagamenti verrà conteggiato l'interesse commerciale.

L'acquirente si impegna a comunicare la propria esatta ragione sociale e partita IVA al momento dell'ordine e sotto la propria responsabilità di verificarla in fattura.

L'acquirente è responsabile della corretta installazione ed uso delle apparecchiature.

Tutte le apparecchiature godono della garanzia di un anno contro difetti di fabbricazione o di materiali, sono esclusi dalla garanzia danni derivanti da un cattivo uso o installazione delle apparecchiature.

Le lampade restano comunque escluse dalla garanzia.

Per ogni controversia è competente il Foro di Viterbo.

Dichiarazione **CE** di conformitàDeclaration **CE** of conformity

La ditta: STUDIO DUE
The firm: Strada Poggino, 100
01100 VITERBO
ITALY

dichiara sotto la propria responsabilità che il prodotto:
declare under our sole responsibility that the product:

- Art. 171045-171042: SLIMBAR FLAT/RGBW
- Art. 171215-171212: SLIMBAR FLAT/WB (white balance)
- Art. 171115-171112: SLIMBAR FLAT/M (monochromatic)

- Art. 201215-201212: SLIMBAR PLUS/RGBW
- Art. 201615-201612: SLIMBAR PLUS/WB (white balance)
- Art. 201415-201412: SLIMBAR PLUS/W (monochromatic)

è conforme alle norme: **CE**
is in conformity with the standard: **CE**

Low Voltage Directive: 2014/35/EU

EN 60529:1991 + A1:2000 + A2:2013
EN 62471:2008
EN 60598-1:2015
EN 60598-2-17:1989 + A2:1991

ECM Directive: 2014/30/EU

EN 61000-3-2:2014	EN 61000-4-2
EN 61000-3-3:2013	EN 61000-4-3
EN 61547:2009	EN 61000-4-4
EN 55103-2:2009	EN 61000-4-5
EN 55015:2013	EN 61000-4-6
EN 55103-1:2009 + A1:2012	EN 61000-4-11

2011/65/EU: RoHS2 Directive

e quindi ai requisiti essenziali delle Direttive:
and therefore according to essential requirement of Directives:

2004/108/EC – Electromagnetic compatibility
2006/95/EC – Low Voltage directive

Data di apposizione: 20
Date of marking:

**RoHS**

PAOLO SENSI
General Manager

VITERBO, 18/04/20

StudioDue

Studio Due Trade s.r.l.
R.E.A. 1494819 · C.F. / P. Iva 14078001006
legal seat: via Raffaele Battistini, 35 · 00151 Roma
operational headquarters: str. Poggino, 100 · 01100 Viterbo (Italy)
tel. 0761.352520 · fax. 0761.352653
e-mail: info@studiodue.com · pec: studioduetrade@pec.it

Doc. 17XX REV 2 - 11/21
SB PILOT series



Dichiarazione di conformità
Declaration of conformity



La ditta: Studio Due Trade s.r.l.
The firm:

dichiara sotto la propria responsabilità che il prodotto:
declare under our sole responsibility that the product:

code **SB PILOT-F series IP67**
code **SB PILOT MAX RGBW**

è conforme alle norme: 
is in conformity with the standard: 

Low Voltage Directive: 2014/35/EU

EN 60529:1991 + A1:2000 + A2:2013
EN 62471:2008
EN 60598-1:2015
EN 60598-2-17:2017

EMC Directive: 2014/30/EU

EN 61000-3-2:2018
EN 61000-3-3:2013 + A1:2017 + A2:2021
EN 61547:2009
EN 55103-2:2009
EN 55015:2014-08
EN 55103-1:2009 + A1:2012

2011/65/EU: RoHS2 Directive



VITERBO,

11/11/2021

ROBERTO FRAIOLI
General Manager

This page is intentionally left blank.

Head Office: STUDIO DUE

Str. Poggino, 100 - 01100 Viterbo (Italy)
tel. +39.0761.352520
fax +39.0761.352653
info@studiodue.com

STUDIO DUE (UK)

3 Encon Court Owl Close
Moulton Park Industrial Estate
Northampton England UK - NN3 6 HZ
tel. +44.1933.650.820
info@studiodue.co.uk

www.studiodue.com
for technical info
service@studiodue.com