

Studio Due[®]

emotion and creativity in light



Color FLOW
RGBW

User manual - Manuale d'uso
art. 230085 - 230087 - 230082

CONNECTORS / CONNETTORI

M19
CONNECTORS

M19 FEMALE
CONNECTOR

48VDC + DMX OUT
INNER VIEW - welding side

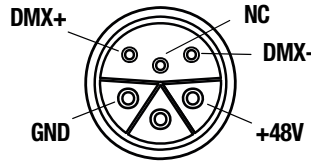

4PIN MALE
CONNECTOR

DMX IN
INNER VIEW - welding side

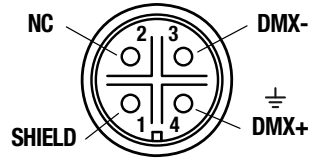

example of
label on the rear
of the fixture

MALE CONNECTOR IN - WELDING VIEW

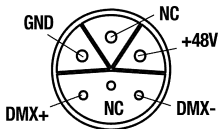

Studio Due
made in ITALY

art. 230085 COLORFLOW RGBW 1m
POWER LINK 15 UNITS MAX
!!! DO NOT DISCONNECT WHEN POWERED !!!



30W

SN

QC

IP 67
Ta 40°C
n.44 LEDs

FEMALE CONNECTOR OUT - WELDING VIEW

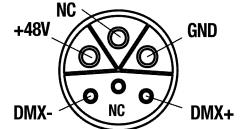

INDEX

- 4 **SAFETY INFORMATION (service personnel) / INFORMAZIONI DI SICUREZZA (personale di servizio)**
- 5 **INTRODUCTION / INTRODUZIONE**
- 6 **TECHNICAL FEATURES / CARATTERISTICHE TECNICHE**
- 10 **EXAMPLE OF CONNECTION DMX CONTROLLER - FIXTURES / ESEMPIO DI COLLEGAMENTO CENTRALINA - FARI**
- 11 **CONNECTION TO THE MAIN POWER / CONNESSIONE ALLA RETE ELETTRICA**
- 12 **CONNECTION TO THE DMX SIGNAL / CONNESSIONE AL SEGNALE DMX**
- 13 **SETUP AND CONFIGURATION BY DRS - DMX REMOTE SETUP /
SETTAGGIO E CONFIGURAZIONE TRAMITE DRS - DMX REMOTE SETUP**
- 15 **DRS MENU' LIST / ELENCO MENU DRS**
- 17 **DMX CHANNEL LIST / LISTA DEI CANALI DMX**
- 20 **PHYSICAL / DIMENSIONI**
- 21 **WARRANTY / GARANZIA**

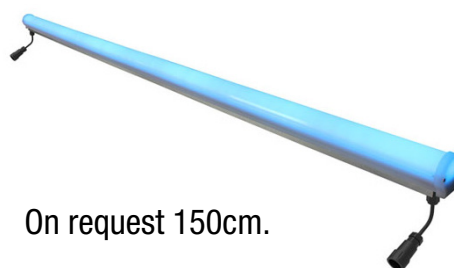
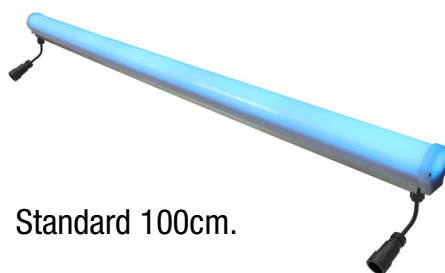

SAFETY INFORMATION (service personnel)

IMPORTANT !

READ ALL CAUTIONS AND WARNINGS PRIOR TO OPERATE THIS EQUIPMENT.

INSTRUCTION TO PREVENT INJURY OR DAMAGE DUE TO ELECTRIC SHOCK, FIRE, MECHANICAL HAZARDS, DANGEROUS MATTERS.

• PROTECTION AGAINST DANGEROUS MATTERS

At the end of its life, must be collected separately. It shouldn't be thrown as waste neither released in the environment. It must be collected from the nearest special waste collection point or consigned to your dealer that provides the service. The incorrect waste disposal can damage the environment and the people for the presence of dangerous substances.

Sanctions are provided for an unauthorized disposal.



• PROTECTION AGAINST FIRE

- 1) Maintain minimum distance of 0,2 meter to lighted objects.
- 2) Replace fuses (if present) only with the specified type and rating.
- 3) Do not install the fixture close to heat sources. Do not lay the connection cable on the fixture when it is warm.
- 4) Fixture designed to be installed on normally flammable surfaces.

• PROTECTION AGAINST ELECTRIC SHOCK

- 1) This equipment must be earthed.
- 2) Class I equipment. The power supply cord includes a protective earthing conductor as part of the cord.
- 3) Disconnect power before servicing (service personnel).
- 4) To replace the LEDs, contact: Studio Due.
- 5) If the external flexible cable of this appliance is damaged, it must only be replaced by the manufacturer, its assistance service, or equivalent qualified personnel, in order to avoid dangers.

• PROTECTION AGAINST MECHANICAL HAZARDS

- 1) Use secondary safety chain when fixing this equipment.
- 2) The protection screens and the lenses must be replaced with genuine parts only if they are visibly damaged and their effectiveness has been reduced, for example, by cracks or deep scratches.
- 3) Do not look directly into the illuminated LEDs of the product for long periods of time. LED lamps can cause eye damage or irritation. Do not look directly into the light source using an optical instrument that focuses on the light beams. The device should be positioned so that there is no prolonged observation of the device at a distance of less than 100cm. (RG1 – IEC/TR 62778:2014).

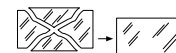

IP67



ITA

INFORMAZIONI DI SICUREZZA (personale di servizio)

IMPORTANTE !

LEGGERE ATTENTAMENTE TUTTI GLI AVVERTIMENTI PRIMA DI COMPIERE QUALUNQUE OPERAZIONE SU QUESTO APPARECCHIO.

ISTRUZIONI PER PREVENIRE LESIONI O DANNI DOVUTI AL FUOCO, ALLE SCOSSE ELETTRICHE, AI RISCHI MECCANICI ED A SOSTANZE PERICOLOSE.

• PROTEZIONE CONTRO SOSTANZE PERICOLOSE

A fine vita è oggetto di raccolta separata, non gettare nei comuni cassonetti di rifiuti urbani, né tantomeno nell'ambiente. Può essere consegnato presso i centri di raccolta delle amministrazioni comunali, oppure presso i rivenditori che forniscono questo servizio. Lo smaltimento errato può causare danni alle persone e all'ambiente per la possibile presenza di sostanze pericolose. Sono previste sanzioni in caso di smaltimento abusivo dei suddetti prodotti.



• PROTEZIONE CONTRO IL FUOCO

- 1) Mantenere la distanza minima di 0,2 metri dagli oggetti illuminati.
- 2) Sostituire i fusibili (se presenti) solo con altri dello stesso tipo e valore.
- 3) Non installare il faro vicino fonti di calore. Non appoggiare il cavo di connessione sul faro quando questo è caldo.
- 4) Questo apparecchio è adatto per il montaggio su superfici normalmente infiammabili.

• PROTEZIONE CONTRO SCOSSE ELETTRICHE

- 1) Questo apparecchio necessita di messa a terra.
- 2) Apparecchio di Classe I. Il conduttore di protezione deve far parte del cavo di alimentazione.
- 3) Disconnettere l'alimentazione prima di aprire l'apparecchio (personale di servizio).
- 4) Per la sostituzione dei LED contattare l'azienda: Studio Due.
- 5) Se il cavo flessibile esterno di questo apparecchio è danneggiato, deve essere sostituito esclusivamente dal costruttore, dal suo servizio di assistenza, o da personale qualificato equivalente, al fine di evitare pericoli.

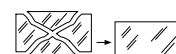

• PROTEZIONE CONTRO RISCHI MECCANICI

- 1) Usare la catena di sicurezza supplementare quando installate l'apparecchio.
- 2) Gli schermi di protezione e le lenti devono essere sostituiti sempre con ricambi originali se sono visibilmente danneggiati e se la loro efficacia è stata ridotta, per esempio, da fessure o incisioni profonde.
- 3) Non guardare direttamente nei LED illuminati del prodotto per lunghi periodi di tempo. Le lampade a LED possono causare danni o irritazione agli occhi. Non guardare direttamente nella sorgente luminosa utilizzando uno strumento ottico che si concentra sui fasci di luce. L'apparecchio dovrebbe essere posizionato in modo che non sia prevista un'osservazione prolungata dell'apparecchio ad una distanza inferiore di 100cm. (RG1 – IEC/TR 62778:2014).

IP67



INTRODUCTION

CHECK THAT THE FIXTURE HAS NOT BEEN DAMAGED DURING TRANSPORT. IF IT HAS BEEN DAMAGED OR IT DOES NOT WORK, ADDRESS THE SELLER. WHETHER THE FIXTURE HAS BEEN SHIPPED TO YOU DIRECTLY, PLEASE CONTACT THE SHIPPING COMPANY. ONLY THE CONSIGNEE (PERSON OR COMPANY) CAN CLAIM FOR THESE DAMAGES.

Thanks for choosing our COLORFLOW RGBW.

Ultra small form factor LED LINEAR TUBE with IP67 rating protection.

Suitable for architectural lighting, visual effects and light games to obtain astonishing effects. Standard 100cm.

To drive COLORFLOW RGBW you can use our POWER BOOST INJECTOR rgbw.

On request: 150cm and 50cm.

On request: adjustable bracket +/- 78°.

Available in 3 different measures:

- Art. 230085 COLORFLOW RGBW 100cm (standard)
- Art. 230087 COLORFLOW RGBW 150cm (on request)
- Art. 230082 COLORFLOW RGBW 50cm (on request)

To obtain the best performances and for a correct functioning of this unit for the years to come, we suggest you to read carefully this manual before connecting or putting the fixture into use.

By doing so you will gain experience with its commands and connections and you will be easily able to use it.

YOUR REFERENCE

Always remember to give the serial number and to specify the model any time you address the seller for information or assistance.

BASIC KIT

- Fixture
- M19 Male and Female connectors (without cable)
- User manual
- Studio Due warranty
- CE standards

INTRODUZIONE

CONTROLLATE CHE L'APPARECCHIO NON ABBA SUBITO ALCUN DANNO DURANTE IL TRASPORTO. SE AVESSE SUBITO DEI DANNI O SE NON DOVESSE FUNZIONARE, RIVOLGETEVI AL VOSTRO RIVENDITORE. SE L'APPARECCHIO VI È STATO SPEDITO DIRETTAMENTE, RIVOLGETEVI SUBITO ALLA DITTA DI TRASPORTO.

SOLO IL DESTINATARIO (LA PERSONA O DITTA RICEVENTE L'APPARECCHIO) PUÒ RECLAMARE PER QUESTO TIPO DI DANNI.

Grazie per aver scelto il nostro COLORFLOW RGBW.

LED LINEAR TUBE RGBW di piccolissime dimensioni lungo 100cm (standard) con grado di protezione IP 67. Adatto ad illuminazione architettonica per creare effetti visivi e giochi di luce. Per controllare il COLORFLOW RGBW potete utilizzare il nostro POWER BOOST INJECTOR rgbw.

A richiesta 150cm e 50cm.

A richiesta: staffa per regolazione +/- 78°.

Disponibile in 3 dimensioni:

- Art. 230085 COLORFLOW RGBW 100cm (standard)
- Art. 230087 COLORFLOW RGBW 150cm (a richiesta)
- Art. 230082 COLORFLOW RGBW 50cm (a richiesta)

Per ottenere il meglio delle prestazioni ed un corretto funzionamento negli anni di questa unità, Vi consigliamo di leggere attentamente questo manuale prima di collegarla e metterla in uso.

In questo modo acquisirete familiarità con i suoi comandi e collegamenti affinché possiate utilizzarla facilmente.

VOSTRA REFERENZA

Citate sempre il numero del modello e di serie ogni volta che Vi rivolgete al vostro rivenditore per informazioni o assistenza.

CONFEZIONE BASE

- Apparecchio
- Connettori M19 maschio e femmina (senza cavo)
- Manuale d'uso
- Garanzia Studio Due
- Dichiarazione CE

TECHNICAL FEATURES / CARATTERISTICHE TECNICHE

COLORFLOW RGBW 100cm (it.230085)

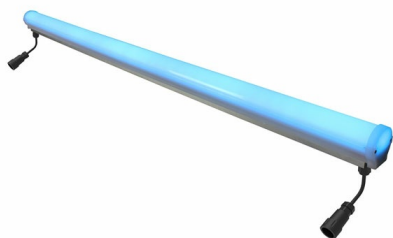

Ultra small form factor LED LINEAR TUBE with IP 67 rating protection 100cm long (standard). Suitable for architectural lighting, visual effects and light games. Aluminium structure and PMMA tube. To drive COLORFLOW RGBW use an external 48VDC Power Supply. On request: adjustable bracket +/-78°. On request 50 and 150cm.

Technical Specification

LED type	RGBW
Number of LEDs	44
Red lumen (lm)	380
Green lumen (lm)	440
Blu lumen (lm)	160
White lumen (lm)	560
Lenses	180°
Control type	DMX - RDM
Setup	RDM/DRS
DMX channels	9ch - 5ch - 4ch
Input range	48VDC
Power max (W)	30
Current	650mA@48VDC
IP protection rating	67
Sizes l x p x h (mm)	1010 x 46
Weight (Kgs)	1,4
Mounting systems	Surface
Colour finishing	None
Marine Grade treatment	None
Product Category	Linear Bar
CF-AB (art.900500)	No Yes

TECHNICAL FEATURES / CARATTERISTICHE TECNICHE

COLORFLOW RGBW 150cm (it.230087)

Ultra small form factor LED LINEAR TUBE with IP 67 rating protection 150cm long. Suitable for architectural lighting, visual effects and light games. Standard 100cm. Aluminium structure and PMMA tube. To drive COLORFLOW RGBW use an external 48VDC Power Supply. On request: adjustable bracket +/-78°. On request 50cm.

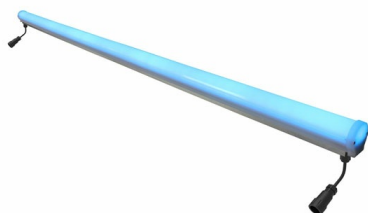

Technical Specification

LED type	RGBW
Number of LEDs	66
Red lumen (lm)	570
Green lumen (lm)	660
Blu lumen (lm)	240
White lumen (lm)	840
Lenses	180°
Control type	DMX - RDM
Setup	RDM/DRS
DMX channels	9ch - 5ch - 4ch
Input range	48VDC
Power max (W)	45
Current	1A@48VDC
IP protection rating	67
Sizes l x p x h (mm)	1510 x 46
Weight (Kgs)	2,1
Mounting systems	Surface
Colour finishing	None
Marine Grade treatment	None
Product Category	Linear Bar
CF-AB (art.900500)	No Yes

TECHNICAL FEATURES / CARATTERISTICHE TECNICHE

COLORFLOW RGBW 50cm (it.230082)

Ultra small form factor LED LINEAR TUBE 50 cm. long with IP 67 rating protection. Suitable for architectural lighting, visual effects and light games. Standard 100cm. Aluminium structure and PMMA tube. To drive COLORFLOW RGBW use an external 48VDC Power Supply. On request: adjustable bracket -/+78°. On request 150cm.



Technical Specification

LED type	RGBW
Number of LEDs	22
Red lumen (lm)	190
Green lumen (lm)	220
Blu lumen (lm)	80
White lumen (lm)	280
Lenses	180°
Control type	DMX - RDM
Setup	RDM/DRS
DMX channels	9ch - 5ch - 4ch
Input range	48VDC
Power max (W)	15
Current	350mA@48VDC
IP protection rating	67
Sizes l x p x h (mm)	510 x 46
Weight (Kgs)	0,7
Mounting systems	Surface
Colour finishing	None
Marine Grade treatment	None
Product Category	Linear Bar
CF-AB (art.900500)	No Yes

TECHNICAL FEATURES / CARATTERISTICHE TECNICHE

POWER BOOST INJECTOR RGBW is a professional power supply + DMX signal IN/THRU Transparent Mode, necessary to control the **COLORFLOW RGBW**.

It allows DMX signal to pass through transparently to connect more than 14 mt of **COLORFLOW RGBW**.

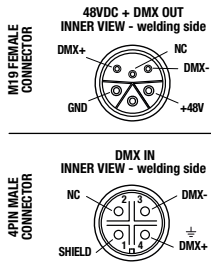

MAIN: 100-277VAC
 1.6A@230VAC
 375W
 OUTPUT: 48VDC - 7.3A
 DATA: IN/THRU - transparent mode
 Output capability: 14mt. of Colorflow RGBW

Studio Due[®]
 made in ITALY

PB-i
 RGBW
Power Boost Injector
 art. 501200

QC

SN

MAIN IN

IP 67

CE UK CA

EXAMPLE OF CONNECTION DMX CONTROLLER - FIXTURES / ESEMPIO DI COLLEGAMENTO CENTRALINA - FARI

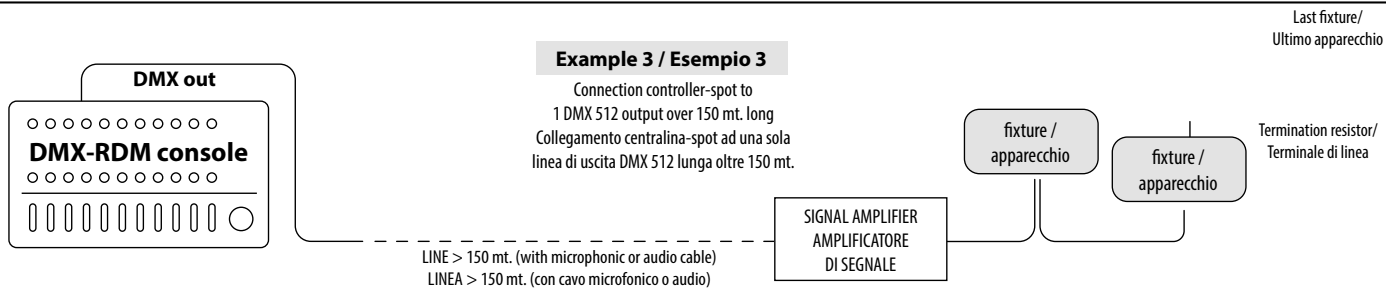
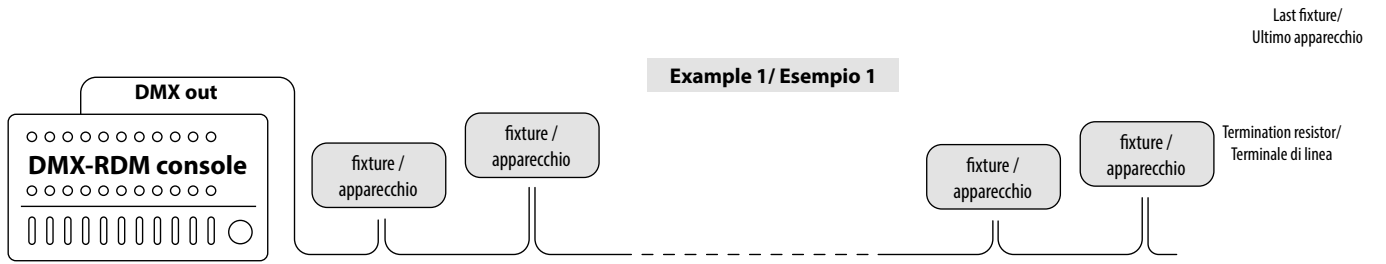

CONNECTION TO THE MAIN POWER / CONNESSIONE ALLA RETE ELETTRICA

This device works at **LOW VOLTAGE**, requiring a **SELV LOW VOLTAGE POWER SUPPLY**.

IMPORTANT: to ensure the protection rating of the fixture, in case of replacement of the conductor cable, refer to the **CONDUCTOR SIZE TABLE**

Questo apparecchio lavora a **BASSA TENSIONE**, necessita di un **ALIMENTATORE LOW VOLTAGE SELV**.

IMPORTANTE: per garantire il grado di protezione dell'apparecchio, in caso di sostituzione del cavo di alimentazione, fare riferimento alla **TABELLA SEZIONE CONDUTTORE**.

ATTENTION - HIGH VOLTAGE!
ALWAYS DISCONNECT THE MAINS SUPPLY BEFORE ACCESS TO THE CONNECTION AREA.

ATTENZIONE - ALTA TENSIONE!
SCOLLEGARE SEMPRE L'ALIMENTAZIONE PRIMA DI APRIRE IL VANO DEI COLLEGAMENTI.

**HYBRID CABLE/
CAVO IBRIDO**

This part of cable is for MAINS VOLTAGE	
MAINS VOLTAGE	CROSS SELECTIONAL AREAS
48VDC	2X1,5 mm ²

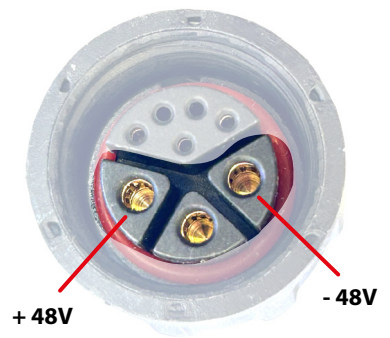
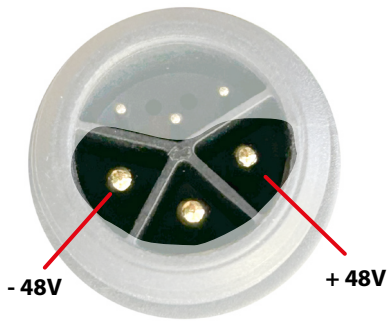
CONNECTION TO THE DMX SIGNAL / CONNESSIONE AL SEGNALE DMX

DMX TERMINAL LINE

The wrong connection of the terminal line or its non-connection are probably the most frequent reasons of the lower DMX signal.

The terminator is a terminal resistor fitted at the end of the cable. (see pict. 1)

The terminal resistor should have the same value as the impedance of the connection cable (120 Ohm).

It is recommended that all DMX 512 systems have the terminal resistor fitted in the end of DMX line.

TERMINALE LINEA DMX

L'incorretto o il mancato collegamento del terminale di linea è probabilmente la più comune causa del difettoso funzionamento della linea DMX.

Il terminale di linea DMX consiste in una resistenza posta alla fine della linea. (vedere fig. 1)

La resistenza terminale dovrebbe avere lo stesso valore dell'impedenza del cavo di collegamento (120 Ohm).

E' raccomandato per tutti i sistemi DMX 512, di inserire il terminale di linea nel connettore di uscita DMX dell'ultimo apparecchio collegato.

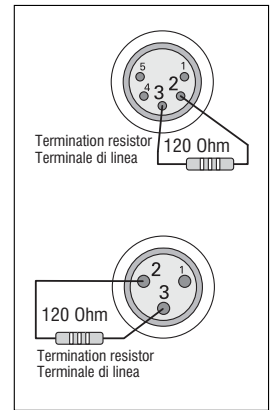

pict. 1

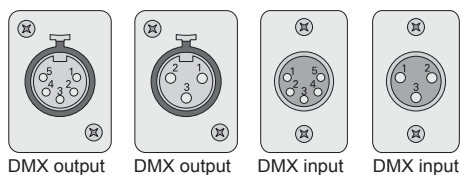
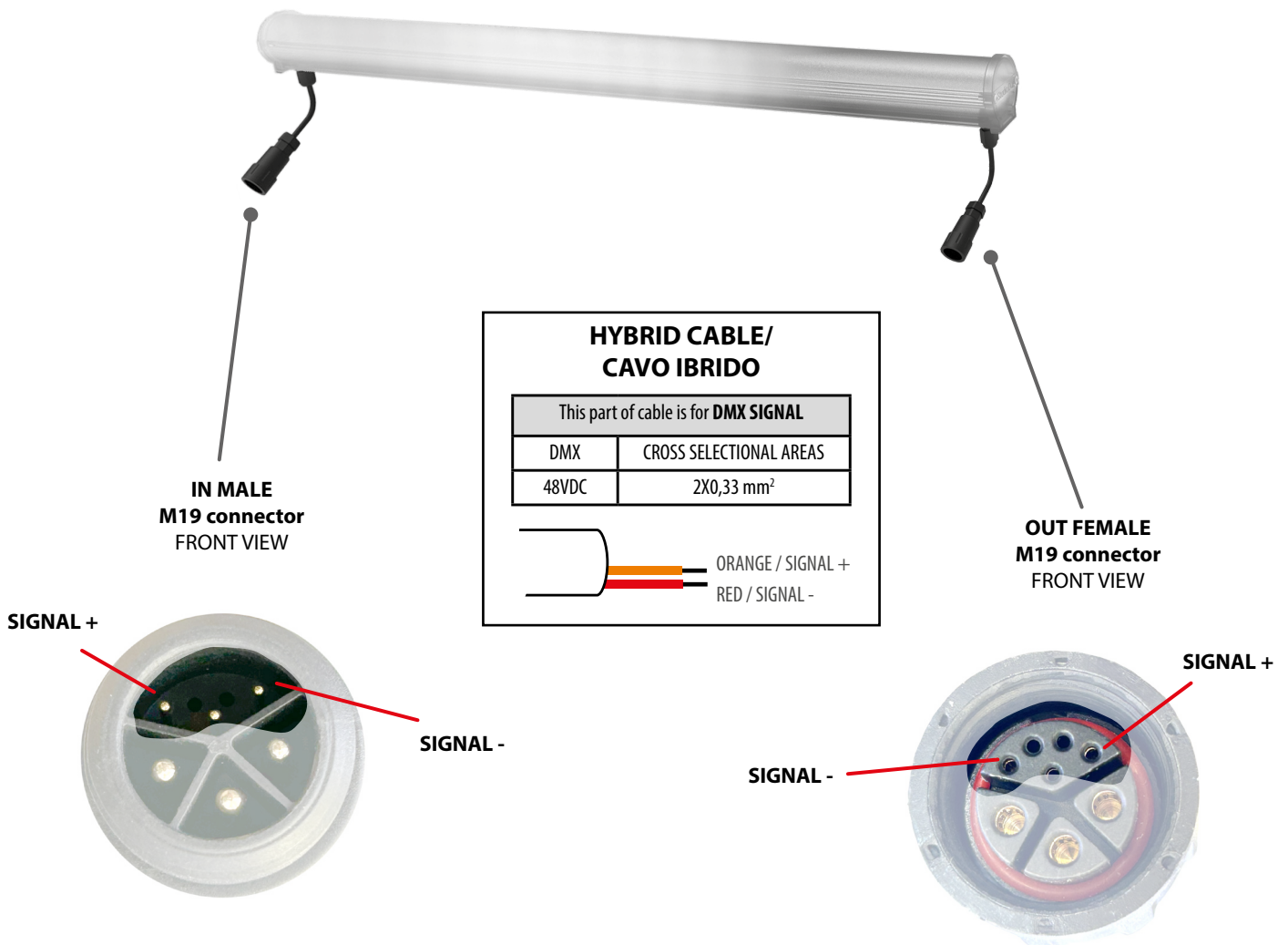

PIN		
1	SHIELD	GROUND/RETURN/OV
2	INNER CONDUCTOR	DATA COMPLEMENT (-, INVERTED)
3	INNER CONDUCTOR	DATA TRUE (+, NON INVERTED)

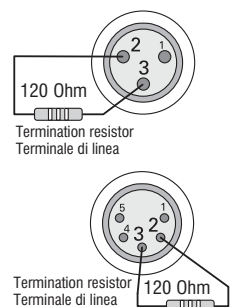

SETUP AND CONFIGURATION BY DRS - DMX REMOTE SETUP

The DRS it's a new concept of professional LED Lighting fixtures suitable for outdoor permanent installations. The LED Lighting fixtures can be driven via DMX through a specific electronic device, the DRS DMX Remote Setup, that grant the possibility to set up the scenarios and the games remotely. These LED Lighting fixtures have installed on board a series of programs including the stand alone function.

The DRS is a simple set up commander that linked with the DMX input of a LED Lighting fixture allow to program all the functions of the luminaire. It's than possible to assign the DMX channel or use the Master/Slave function. The device is powered through battery.

SETTAGGIO E CONFIGURAZIONE TRAMITE DRS - DMX REMOTE SETUP

DRS è il nuovo concetto dell'illuminazione LED per uso professionale nelle installazioni esterne permanenti. Gli apparecchi LED possono essere controllati e configurati tramite uno specifico controller: il DRS, DMX Remote Setup, il quale consente di programmare e configurare scene e giochi di luce in modalità remota. Questi apparecchi LED hanno installati a bordo una serie di giochi che includono la funzione stand alone.

Il DRS, DMX Remote Setup, è un semplice set-up commander che collegato via DMX ad un'apparecchio consente la sua programmazione e configurazione. E' possibile assegnare agli apparecchi collegati i canali DMX o utilizzzare la funzione Master/Slave. Il DRS è alimentato a batterie.

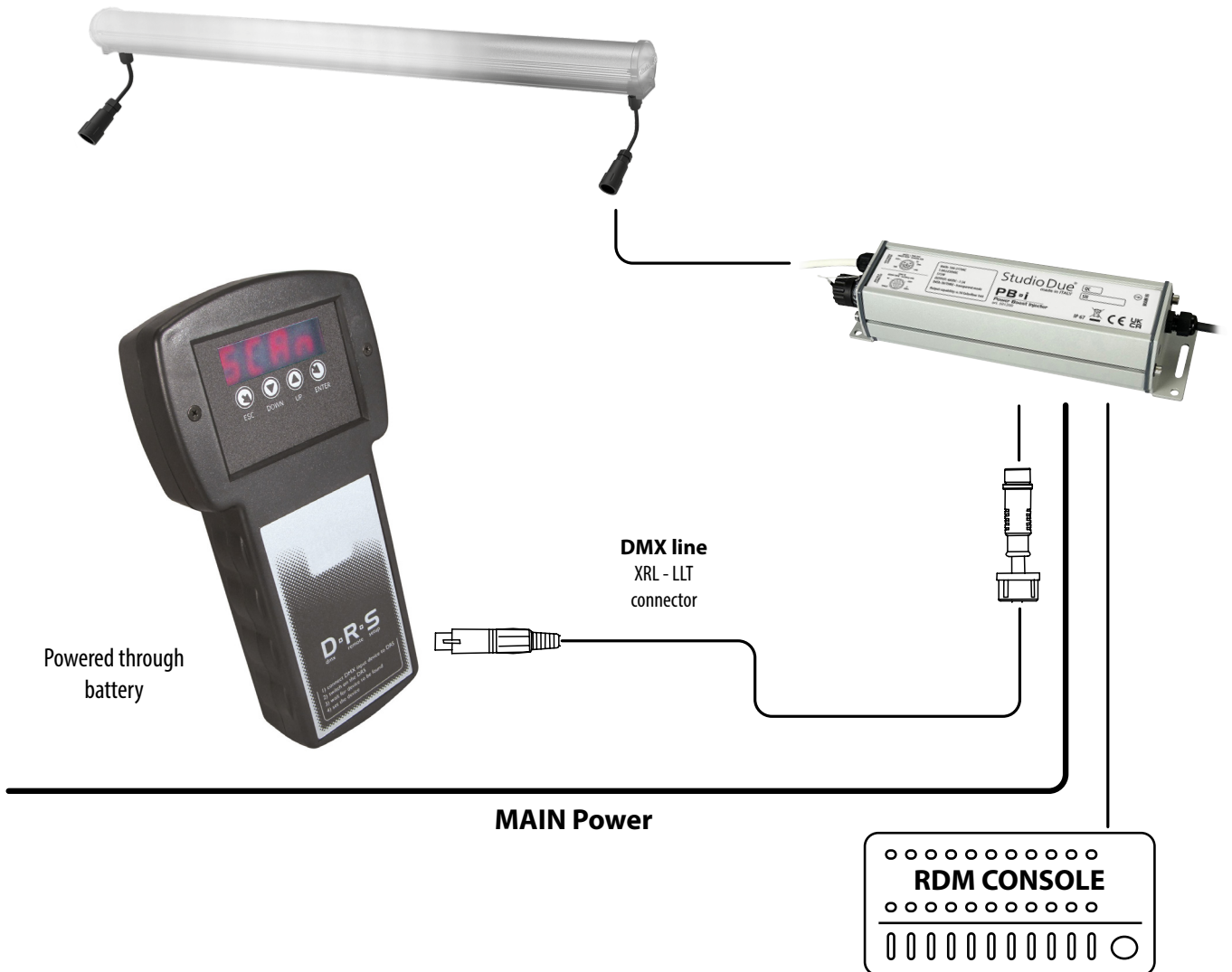

SETUP AND CONFIGURATION BY DRS - DMX REMOTE SETUP

To make the set-up of the various fixture parameter, proceed as follow:

- Disconnect the fixture to set-up from the other DMX/RDM devices

- Connect the DMX cable of the fixture to the DRS commander

-  Switch on the DRS commander and wait for the **8888** sign

-  If the DRS commander detects a compatible DRS device, displays shortly the **Conn** written and afterwards, displays the name of the fixture and its software version.

-  If the DRS commander don't detects any compatible DRS device or is present any malfunction, the display shows the **SCAn** written

-  When the detection sequence is finished, the display shows the first menu

-  The UP/DOWN buttons allow to scroll forward/backward the menu list

-  The ENTER button allow to confirm the selected option (if the parameter is flashing)

-  ESC button allow to delete the operation and return to a previous menu level

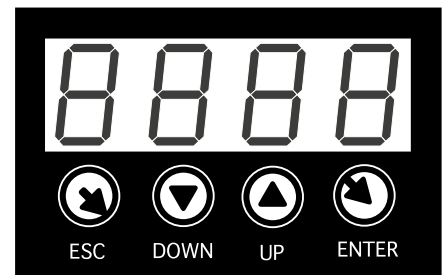

SETTAGGIO E CONFIGURAZIONE TRAMITE DRS - DMX REMOTE SETUP

Per effettuare la programmazione dei vari parametri di un apparecchio, è necessario procedere come segue:

- Disconnettere l'apparecchio da configurare da altri dispositivi DMX/RDM

- Collegare il cavo DMX dell'apparecchio da configurare, al programmatore DRS

-  Accendere il programmatore DRS ed attendere che visualizzi la scritta **8888**

-  Se il programmatore DRS individua un dispositivo DRS compatibile, visualizza per qualche istante la scritta **Conn** e, successivamente, visualizza il nome dell'apparecchio e la relativa versione software

-  Se il programmatore DRS non individua alcun dispositivo DRS compatibile o è presente qualche malfunzionamento il display visualizzerà la scritta **SCAn**

-  Una volta terminata la sequenza di riconoscimento, viene visualizzato il primo menu dell'apparecchio

-  I pulsanti UP/DOWN permettono di scorrere la lista dei menu

-  Il pulsante ENTER permettere di entrare in un menu o di confermare una opzione in caso di lampeggio del parametro

-  Il pulsante ESC annulla una operazione o torna al livello di menu inferiore.

DRS MENU' LIST / ELENCO MENU DRS

Switching on the fixture you can see the model and the software version. For example:
All'accensione, viene visualizzato il modello di apparecchio e la versione software. Per esempio:

--> CLF rgbw --> 1-00 - than it's shown the fist menu / poi viene visualizzato il primo menu

Address (Addr)



Set the DMX channel address / Imposta il canale DMX
> Select the channel number .. **c001** .. **c002** .. whit the UP/DOWN buttons. Press ENTER.
> Selezionate il canale desiderato .. **c001** .. **c002** .. con i tasti UP/DOWN. Premere ENTER.

Auto Mode (ModE)



Set the DMX, SLAVE or MASTER mode / Imposta la modalità DMX, SLAVE o MASTER
> Select the value **no** .. **sl** .. **pr01** .. **pr02** .. with the UP/DOWN buttons. Press ENTER.
> Selezionate il valore desiderato **no** .. **sl** .. **pr01** .. **pr02** .. con i tasti UP/DOWN. Premere ENTER.

Auto Speed (PrSP)



Set the preset execution speed / Imposta la velocità di esecuzione dei giochi interni
> Select the value **+400%** .. **-400%** with the UP/DOWN buttons. Press ENTER.
> Selezionate il valore desiderato **+400%** .. **-400%** con i tasti UP/DOWN. Premere ENTER.

Wireless enable (ULEn)



Enable or disable the wireless reception / Consente o non consente la ricezione wireless. (ON, OFF)
The cable reception is disabled / La ricezione via cavo viene disabilita
> Select the value **on** .. **off** .. with the UP/DOWN buttons. The written is flashing, press ENTER.
> Selezionate il valore desiderato **on** .. **off** .. con i tasti UP/DOWN. La scritta lampeggia, premere ENTER.

Wireless unlink (ULPA)



Remove the link from the fixture to the associated transmitter (PA?). Press ENTER.
Elimina il link tra l'apparecchio e il trasmettitore al quale è stato associato. Premere ENTER.

Wireless bridge (ULbr)



If wireless is ON, enable the transmission of the received data by cable to the other fixtures
Se il wireless è attivo, consente la trasmissione dati agli altri apparecchi collegati via cavo. (ON, OFF)
> Select the value **on** .. **off** .. with the UP/DOWN buttons. Press ENTER.
> Selezionate il valore desiderato **on** .. **off** .. con i tasti UP/DOWN. Premere ENTER.

Scene (Scne)

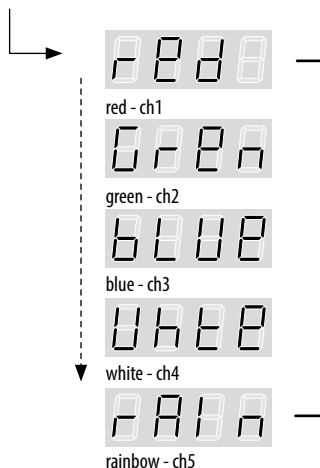

If ON:
For each color or menu it is possible to varying and than set-up the value from 0 to 255 without having to confirm with the ENTER key.
These functions are auto-save.

Se ON:
Per ogni singolo colore o menu, è possibile variare e quindi impostare il valore da 0 a 255 senza dover confermare con il tasto ENTER.
Queste funzioni si salvano automaticamente.

N. Channels (nChn)



Set the DMX channels of the fixture / Imposta il numero di canali DMX dell'apparecchio. (10, 7, 6, 5)
> Select the value, e.g. .. **9**.. **6** etc. with the UP/DOWN buttons. Press ENTER.
> Selezionate il valore desiderato, per esempio .. **9** .. **6** etc. con i tasti UP/DOWN. Premere ENTER.

Flicker free function (FLcr)



Flicker free function / Funzione flicker free. (F1, F2)
> Select the value **f1** .. **f2**
> Selezionate il valore desiderato **f1** .. **f2**

Smooth Dimming (SMth)



Set the interpolation type for the smooth dimming function
Imposta il tipo di interpolazione per la funzione smooth dimming. (OFF, Sd1, Sd2, Sd3)
> Select the value **oFF** .. **LoW** .. **Mld** .. **hIGH** with the UP/DOWN buttons. Press ENTER.
> Selezionate il valore desiderato **oFF** .. **LoW** .. **Mld** .. **hIGH** con i tasti UP/DOWN. Premere ENTER.

Halogen Simulation (HALS)



Set the halogen simulation function mode

Imposta il funzionamento della modalità simulazione lampada alogena. (OFF, Mod1, Mod2)

> Select the value **oFF** .. **MId1** .. **MId2** with the UP/DOWN buttons. Press ENTER.

> Selezionate il valore desiderato **oFF** .. **MId1** .. **MId2** con i tasti UP/DOWN. Premere ENTER.

CYM Emulation (CYMS)



Set the fixture to work in CYM or RGB emulation system

Imposta l'apparecchio per funzionare come emulatore di sistema CYM o RGB. (CYM, RGB)

> Select the value **oFF** >> **RGB** or **on** >> **CYM** with the UP/DOWN buttons. Press ENTER.

> Selezionate il valore desiderato **oFF** >> **RGB** oppure **on** >> **CYM** con i tasti UP/DOWN. Premere ENTER.

Test (tEst)



Enables the test of the fixture and execute a factory program to check the right functioning/

Abilita il test dell'apparecchio ed esegue un programma di fabbrica per verificarne il funzionamento. (T-ON)

> Select the value **t-on** with the UP/DOWN buttons. T-on is flashing: test in progress. Press any key to exit.

> Selezionate il valore **t-on** con i tasti UP/DOWN. T-on lampeggia: test in corso. Premere qualsiasi tasto per uscire.

Reset (rSEt)



Execute a reset of the electronic section / Esegue un reset della parte elettronica. (rS?)

Format (FrMt)



Restore the factory setting (Require confirmation).

Ripristina le impostazioni di fabbrica (Viene chiesta conferma). (Fm?)

DMX CHANNEL LIST / LISTA DEI CANALI DMX

DMX Channels list 9Ch / Lista dei canali DMX 9Ch

8 BIT	FUNCTION	0 31 63 95 127 159 191 233 255
CH1	RED	
CH2	GREEN	
CH3	BLUE	
CH4	WHITE	
CH5	STROBE	
CH6	DIMMER	
CH7	LED FADE TIME	
CH8	RAINBOW	
CH9	BALANCED WHITE	

DMX Channels list 6Ch / Lista dei canali DMX 6Ch

8 BIT	FUNCTION	0 31 63 95 127 159 191 233 255
CH1	RED	
CH2	GREEN	
CH3	BLUE	
CH4	WHITE	
CH5	DIMMER	
CH6	RAINBOW	

DMX Channels list 5Ch / Lista dei canali DMX 5Ch

8 BIT	FUNCTION	0 31 63 95 127 159 191 233 255									
		[Scale with 10 major ticks and 100 minor ticks]									
CH1	RED	[Color gradient from black to red]									
CH2	GREEN	[Color gradient from black to green]									
CH3	BLUE	[Color gradient from black to blue]									
CH4	WHITE	[Color gradient from black to white]									
CH5	DIMMER	[Color gradient from black to white]									

DMX Channels list 4Ch / Lista dei canali DMX 4Ch

8 BIT	FUNCTION	0 31 63 95 127 159 191 233 255									
		[Scale with 10 major ticks and 100 minor ticks]									
CH1	RED	[Color gradient from black to red]									
CH2	GREEN	[Color gradient from black to green]									
CH3	BLUE	[Color gradient from black to blue]									
CH4	WHITE	[Color gradient from black to white]									

this page is intentionally left blank / questa pagina è stata lasciata intenzionalmente bianca

PHYSICAL / DIMENSIONI

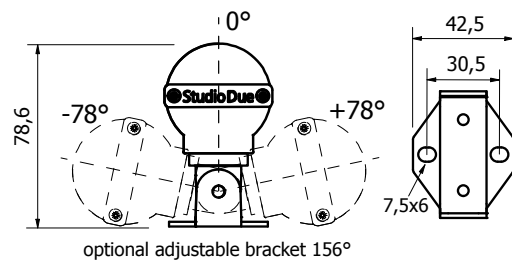
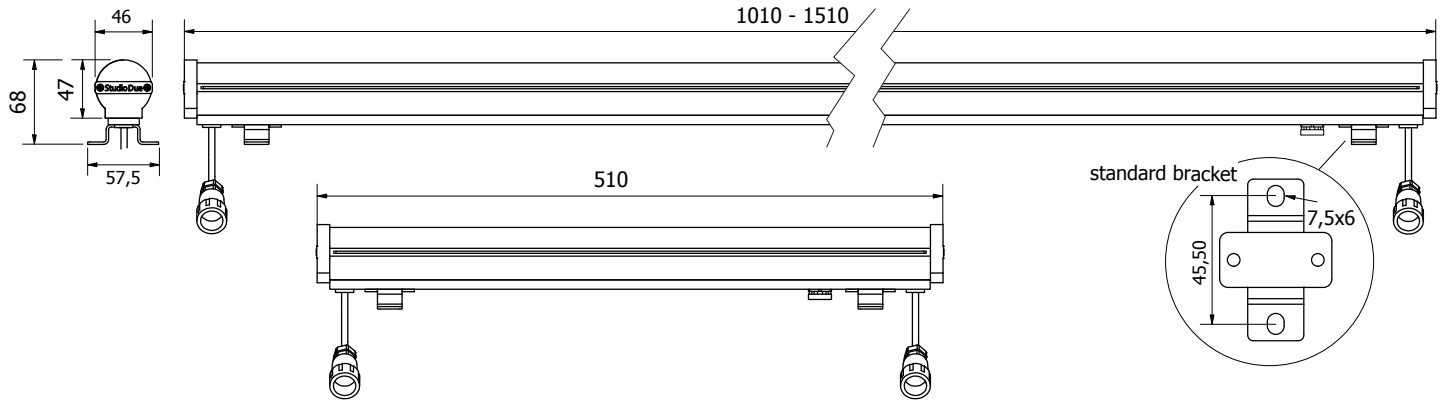

Warranty CARD

Studio Due®

Company name:

Mr./Mrs./Miss:

Address:

Tel. or E-mail :

Dealer:

SALE CONDITIONS

1) Price quoted are not inclusive of lamp and package.
The packing fee is 2% of the net price for all items.
These prices should be subject to possible variations for eventual rises of production costs or duties.
Claims for possible damages during the freight, must be notified to the carrier.
Any claim must be notified within 8 days from the receipt of the goods.
The buyer is responsible of the right installation and use of the apparatus.
All the apparatuses are guaranteed for one year against defects of manufacture or materials.
Defects and breakages caused by wrong connection or use of the apparatuses are not subject to guarantee.
The lamp is excluded from the warranty.
For any dispute is competent the Tribunal of Viterbo.

CONDIZIONI DI VENDITA

1) I prezzi riportati sono esclusi di IVA, lampada ed imballaggio.
Il costo del contributo di imballaggio è del 2% sul prezzo netto per tutti gli articoli.
Detti prezzi possono essere soggetti a possibili variazioni per eventuali aumenti dei costi di produzione o imposte.
La merce viaggia a rischio e pericolo del committente, anche se in porto franco.
Reclami per possibili danni durante il trasporto, dovranno essere fatti esclusivamente al vettore.
Eventuali osservazioni sulle merci ricevute dovranno esserci notificate entro e non oltre 8 giorni dal ricevimento delle medesime. Sui ritardi dei pagamenti verrà conteggiato l'interesse commerciale.
L'acquirente si impegna a comunicare la propria esatta ragione sociale e partita IVA al momento dell'ordine e sotto la propria responsabilità di verificarla in fattura.
L'acquirente è responsabile della corretta installazione ed uso delle apparecchiature.
Tutte le apparecchiature godono della garanzia di un anno contro difetti di fabbricazione o di materiali, sono esclusi dalla garanzia danni derivanti da un cattivo uso o installazione delle apparecchiature.
Le lampade restano comunque escluse dalla garanzia.
Per ogni controversia è competente il Foro di Viterbo.

Dichiarazione di conformità
Declaration of conformity
Déclaration de conformité



La ditta:
The firm: **Studio Due Trade s.r.l.**
L'entreprise:

dichiara sotto la propria responsabilità che il prodotto:
declare under our sole responsibility that the product:
déclare sous sa propre responsabilité que le produit:

COLORFLOW RGBW series IP67 (all models)

Art. 230085
Art. 230087
Art. 230082

è conforme alle norme:
is in conformity with the standard:
est conforme aux normes:



Low Voltage Directive: 2014/35/EU

EN 60598-1:2015
EN 62471:2008
EN 60529:1991 + A1:2000 + A2:2013
EN 60598.2.5:2015

EMC Directive: 2014/30/EU

EN 55103-1:2009 + A1:2012
EN 55015:2014
EN 55103-2:2009
EN 61547:2009
EN 61000-3-2:2014
EN 61000-3-3:2013

2011/65/EU: RoHS2 Directive

Data di apposizione:
Date of marking:
Date d'apposition:

23



VITERBO,

19/04/23

ROBERTO FRAIOLI
General Manager

this page is intentionally left blank / questa pagina è stata lasciata intenzionalmente bianca

Studio Due[®]

emotion and creativity in light

Head Office: STUDIO DUE s.r.l. (I)

Str. Poggino, 100 - 01100 Viterbo (Italy)
tel. +39.0761.352520
fax +39.0761.352653
info@studiodue.com

STUDIO DUE (UK)

3 Encon Court Owl Close
Moulton Park Industrial Estate
Northampton England UK - NN3 6 HZ
tel. +44.1933.650.820
info@studiodue.co.uk

www.studiodue.com
for technical info
service@studiodue.com