



new products
2015



Studio Due
emotion and creativity in light





Studio Due products are in conformity with the european standards,
and therefore according to essential requirements of directives:
LV 73/23 and 93/68 EEC • EMC 89/336 and 93/68 EEC.
Specifications and product images are subject to change without notice.



INDEX

pag. 4 T-Bright
 pag. 5 T-Bright

- RGBW full color
 - monochromatic



pag. 6 Archibar SL300
 4 sizes: 60cm, 90cm, 120cm, 150cm

- RGBW full color



pag. 7 Archibar SL200
 4 sizes: 60cm, 90cm, 120cm, 150cm

- RGBW full color
 - monochromatic
 - white balance



pag. 8 Archibar SL100
 4 sizes: 60cm, 90cm, 120cm, 150cm

- RGBW full color
 - monochromatic
 - white balance



pag. 9 Archibar ST70
 4 sizes: 60cm, 90cm, 120cm, 150cm

- RGB+W



pag. 10 Archibar ST70/W
 5 sizes: 30cm, 60cm, 90cm, 120cm, 150cm

- white



pag. 11 Parbar

- RGBW full color



pag. 12 Parled 100
 Parled 100 drs

- RGBW full color
 - RGBW full color



pag. 13 Parled 100/M
 Parled 100/M drs

- monochromatic
 - monochromatic



pag. 14 Parspot

- monochromatic



pag. 15 Parled 200/WB

- white balance



pag. 16 WS 100

- white



pag. 17 M-Terra

- RGBW full color
 - monochromatic



pag. 18 M-Aria

- RGBW full color
 - monochromatic



T-Bright 500

RGBW full color

art. 1525



TECHNICAL SPECIFICATIONS

SOURCE

n. 30 RGBW-FC high power LEDs

Total light power: 340W

Total out lumen: R 3300lm, G 4700lm, B 900lm, W 6200lm

OPTIC

25° (45 mm lenses)

On request: narrow, wide, elliptic 45 mm lenses

MANUAL TILT 160°

CONTROL

Standard interface: RS-485; opto-couplet input

Protocol: USITT DMX 512

CONNECTIONS

Signal: XRL 5pin (on request 3pin) IP 64 connector (male-female)
possibility to link up to 32 devices in chain

Available as accessories:

- Wireless DMX receiver

Main Power: POWERCON 3pin IP 64 connector (male-female)

possibility to link up to 6 devices at 230V or 3 devices at 120V in chain.

SETUP AND CONFIGURATION

Control panel with touch technology and led display with flip function
or by DRS (remote control device)

Dedicated DMX channel for white balance

DMX or Auto mode with Master-Slave function

Intelligent temperature control

Halogen simulation

CYM simulation

Flicker-free function

Smooth dimming function

IP 64 RATING PROTECTION

POWER SUPPLY

Voltage range: 100-240VAC

Frequency range: 47-63Hz

Active Power factor:

PF>0.92/230VAC, PF>0.94/120VAC

Current:

1.65A@230VAC, 3.2A@120V 370W

Fuse T8A (inside fixture)

DMX CHANNELS

9CH mode, 6CH mode, 5CH mode, 4CH mode

PHYSICAL

WxDxH: 406x185x398 mm - Weight: 13 Kg.



T-Bright 400

white balance

art. 15251/WR
art. 15252/WL



T-Bright WL



T-Bright WR

TECHNICAL SPECIFICATIONS

SOURCE

n. 30 3000K high power white LEDs
n. 30 6000K high power white LEDs
Total out lumen: 33.000lm (18.000 cold white + 15.000 warm white)
Total light power: 270W

OPTIC

70°x55° (antiglare square reflectors) - art. /WR only
25° (38 mm lenses) - art. /WL
On request: narrow, wide 38 mm lenses

MANUAL TILT 160°

CONTROL

Standard interface: RS-485; opto-couplet input
Protocol: USITT DMX512

CONNECTIONS

Signal: XRL 5pin (on request 3pin) IP 64 connector (male-female)
possibility to link up to 32 devices in chain
Available as accessories:
- Wireless DMX receiver
Main Power: POWERCON 3pin IP 64 connector (male-female)
possibility to link up to 8 devices at 230V or 4 devices at 120V in chain.

SAFETY

n. 2 eyebolts for safety chains

IP 64 RATING PROTECTION

POWER SUPPLY

Voltage range: 100-240VAC
Frequency range: 47-63Hz
Active Power factor:
PF>0.95/230VAC, PF>0.98/120VAC
Current:
1.35A@230VAC, 2.6A@120V 300W
Fuse T8A (inside fixture)

DMX CHANNELS

4CH mode, 2CH mode, 1CH mode

PHYSICAL

WxDxH: 406x185x398 mm - Weight: 13 Kg.



Archibar SL300

RGBW full color

art. 1519: SL300/FC

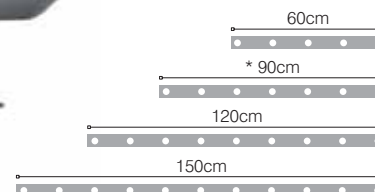

TECHNICAL SPECIFICATIONS (standard 90cm)

SOURCE

n. 15 RGBW-FC-LEDs

Total out lumen:
R 1350lm, G 2250lm, B 450lm, W 3300lm
Total light power:
140W

OPTIC

25° (45 mm lenses)
On request: narrow, wide, elliptic 45 mm lenses

MANUAL TILT 160°

CONTROL

Standard interface: RS-485
Protocol: USITT DMX512

CONNECTIONS

Signal: 4pin IP 67 connector (male-female)
possibility to link up to 32 devices in chain
Available as accessories:
- Wireless DMX receiver
Main Power: 3pin IP 67 connector (male-female)
possibility to link up to 6 devices at 230V or 3 devices at 120V in chain.

SAFETY

n. 2 eyebolts for safety chains

SETUP AND CONFIGURATION

Control panel with touch technology and led display with flip function
or by DRS (remote control device)
Dedicated DMX channel for white balance
DMX or Auto mode with Master-Slave function
Intelligent temperature control
Halogen simulation
CYM simulation
Flicker-free function
Smooth dimming function

IP 67 RATING PROTECTION

POWER SUPPLY

Voltage range: 100-240VAC
Frequency range: 47-63Hz
Active Power factor:
PF > 0.94/230VAC, PF > 0.98/120VAC
Current:
0.70A@230VAC, 1.25A@120V
Power: 150W
Fuse T5A (inside fixture)

DMX CHANNELS

9CH mode, 6CH mode, 5CH mode, 4CH mode

PHYSICAL

WxDxH: 928 x 110 x 93 mm (dimension of profile)
Weight: 6,7 Kg.



the control panel with touch technology



in/out DMX



in/out main power

Archibar SL200

RGBW full color
monochromatic . white balance

art. 1518: SL200/FC
art. 15181: SL200/M
art. 15182: SL200/WB

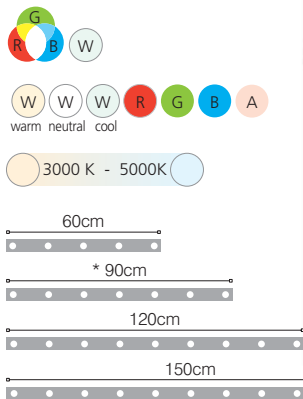

TECHNICAL SPECIFICATIONS (standard 90cm)

SOURCE

n. 15 RGBW-FC-LEDs

Total out lumen:
R 1050lm, G 1755lm, B 300lm, W 2250lm
Total light power:
100W

OPTIC

15X30° (38 mm lenses)
On request: narrow, wide 38 mm lenses

MANUAL TILT 160°

CONTROL

Standard interface: RS-485
Protocol: USITT DMX512

CONNECTIONS

Signal: 4pin IP 67 connector (male-female)
possibility to link up to 32 devices in chain
Available as accessories:
- Wireless DMX receiver
Main Power: 3pin IP 67 connector (male-female)
possibility to link up to 8 devices at 230V or 4 devices at 120V in chain.

SAFETY

n. 2 eyebolts for safety chains

SETUP AND CONFIGURATION

Control panel with touch technology and led display with flip function
or by DRS (remote control device)
Dedicated DMX channel for white balance
DMX or Auto mode with Master-Slave function
Intelligent temperature control
Halogen simulation
CYM simulation
Flicker-free function
Smooth dimming function

IP 67 RATING PROTECTION

POWER SUPPLY

Voltage range: 100-240VAC
Frequency range: 47-63Hz
Active Power factor:
PF > 0.94/230VAC, PF > 0.98/120VAC
Current:
0.50A@230VAC, 0.9A@120V
Power: 105W
Fuse T3.15A (inside fixture)

DMX CHANNELS

9CH mode, 6CH mode, 5CH mode, 4CH mode

PHYSICAL

WxDxH: 928x110x93 mm (dimension of profile)
Weight: 6 Kg.



Archibar SL100

RGBW full color
monochromatic . white balance

art. 1517: SL100/FC
art. 15171: SL100/M
art. 15172: SL100/WB

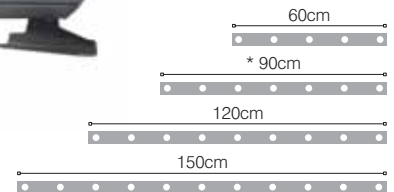
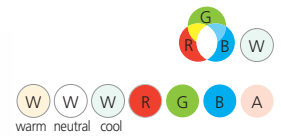

TECHNICAL SPECIFICATIONS (standard 90cm)

SOURCE

n. 7 RGBW-FC-LEDs

Total out lumen:
R 600lm, G 780lm, B 180lm, W 1200lm
Total light power:
49W

OPTIC

15X30° (38 mm lenses)
On request: narrow, wide 38 mm lenses

MANUAL TILT 160°

CONTROL

Standard interface: RS-485
Protocol: USITT DMX512

CONNECTIONS

Signal: 3pin IP 67 connector (male-female)
possibility to link up to 32 devices in chain
Available as accessories:
- Wireless DMX receiver
Main Power: 3pin IP 67 connector (male-female)
possibility to link up to 10 devices at 230V or 6 devices at 120V in chain.

SAFETY

n. 2 eyebolts for safety chains

IP 67 RATING PROTECTION

SETUP AND CONFIGURATION

By DRS (remote control device)
Dedicated DMX channel for white balance
DMX or Auto mode with Master-Slave function
Intelligent temperature control
Halogen simulation
CYM simulation
Flicker-free function
Smooth dimming function

POWER SUPPLY

Voltage range: 100-240VAC
Frequency range: 47-63Hz
Active Power factor:
PF>0.94/230VAC, PF>0.99/120VAC
Current:
0.25A@230VAC, 0.45A@120V
Power: 55W
Fuse T3.15A (inside fixture)

DMX CHANNELS

9CH mode, 6CH mode, 5CH mode, 4CH mode

PHYSICAL

WxDxH: 928 x60x91,4mm (dimension of profile)
Weight: 3,8 Kg.



Archibar ST70

RGB+W

art. 1516: ST70/RGB+W

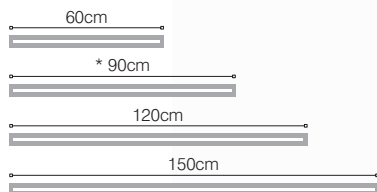

TECHNICAL SPECIFICATIONS (standard 90cm)

SOURCE

n. 108 RGB LEDs + n. 54 White LEDs

Total out lumen:

R 360lm, G 600lm, B 150lm, W 1200lm

Total light power:

30W

OPTIC

120°

MANUAL TILT 160°

CONTROL

Standard interface: RS-485

Protocol: USITT DMX512

CONNECTIONS

Signal: 3pin IP 67 connector (male-female)

possibility to link up to 32 devices in chain

Main Power: 3pin IP 67 connector (male-female)

possibility to link up to 10 devices at 230V or 6 devices at 120V in chain.

SAFETY

n. 2 eyebolts for safety chains

IP 67 RATING PROTECTION

SETUP AND CONFIGURATION

By DRS (remote control device)

Dedicated DMX channel for white balance

DMX or Auto mode with Master-Slave function

Halogen simulation

CYM simulation

Flicker-free function

Smooth dimming function

POWER SUPPLY

Voltage range: 100-240VAC

Frequency range: 47-63Hz

PF > 0.6/230VAC

Current:

0.38A@230VAC, 0.64A@120V

Power: 45W

Fuse T3.15A (inside fixture)

DMX CHANNELS

9CH mode, 6CH mode, 5CH mode, 4CH mode

PHYSICAL

WxDxH: 928x60x91,4mm (dimension of profile)

Weight: 3,8 Kg.



Archibar ST70/W

white

art. 1515: ST70/W

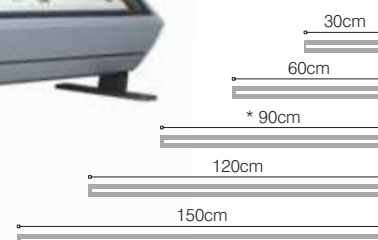

TECHNICAL SPECIFICATIONS (standard 90cm)

SOURCE

n. 108 Mid-Power White LEDs

Total out lumen:
7200lm
Total light power:
51W

OPTIC

120°

MANUAL TILT 160°

CONNECTIONS

3x1mm 1.5mt cable

SAFETY

n. 2 eyebolts for safety chains

IP 67 RATING PROTECTION

POWER SUPPLY

Voltage range: 100-240VAC
Frequency range: 47-63Hz
Active Power factor:
PF>0.92/230VAC, PF>0.98/120VAC
Current:
0.27A@230VAC, 0.48A@120V
Power: 56W

PHYSICAL

WxDxH: 910x60x91,4mm (dimension of profile)
Weight: 3,8 Kg.



art. 1510



TECHNICAL SPECIFICATIONS

SOURCE

n. 14x4 RGBW LEDs
Red 4000lm, Green 7000lm, Blue 1200lm, White 8500lm

OPTIC

15° (38 mm lenses)
On request: medium, wide 38 mm lenses

MANUAL PAN 160° TILT 240°

CONTROL

Standard interface: RS-485; opto-couplet input
Protocol: USITT DMX 512

CONNECTIONS

Signal: XRL 5pin (on request 3pin) connector (male-female)
Available as accessories:
- Wireless DMX receiver
Main Power: POWERCON 3pin connector (male-female)
possibility to link up to 6 devices at 230V or 3 devices at 120V in chain.

SETUP AND CONFIGURATION

Control panel with 4 push buttons
LCD display for setup + 3 digit LED for DMX channel view
Display with flip function
Dedicated DMX channel for white balance
DMX or automatic mode with MASTER/SLAVE function
Intelligent temperature control
Flicker free function
Smooth dimming function
Halogen simulation
CYM emulation
Remote configuration by DRS Setup device

POWER SUPPLY

Voltage range: 100-240VAC
Frequency range: 47-63Hz
Active Power factor: PF>0.99/230VAC, PF>0.99/120VAC
1.6A@230VAC, 3A@120V
Power: 360W
Fuse T6,3A

DMX CHANNELS

21CH mode

PHYSICAL

WxDxH: 1250x160x340 mm - Weight: 16,5 Kg.

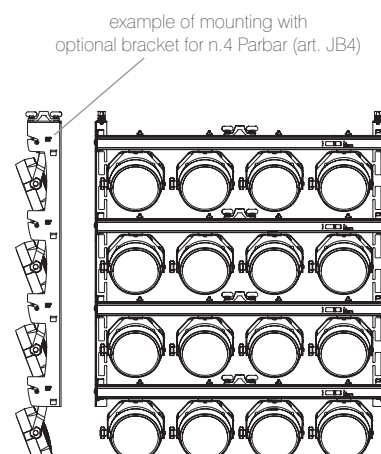
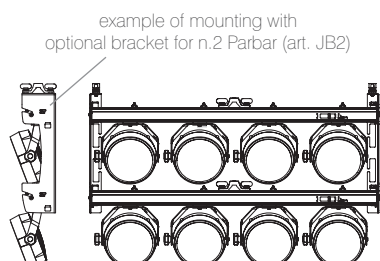

Parled 100

RGBW full color

art. 1506: 100/FC
art. 1507: 100/FC DRS



TECHNICAL SPECIFICATIONS

SOURCE

n. 7 RGBW LEDs
Red 500lm, Green 820lm, Blue 150lm, White 1050lm

OPTIC

25° (32 mm lenses)
On request: narrow, wide 32 mm lenses

MANUAL TILT 360°

CONTROL

Standard interface: RS-485
Protocol: USITT DMX 512

CONNECTIONS

Signal: XRL 5pin (on request 3pin) male-female connector (art. 1506)
4pin IP 67 male-female connector (art. 1507)
Main Power: 3x1mm cable

SETUP AND CONFIGURATION

Control panel with 4 push buttons (art. 1506 only)
LED display with flip function (art. 1506 only)
Remote configuration by DRS Setup device
Dedicated DMX channel for white balance
DMX or automatic mode with MASTER/SLAVE function
Intelligent temperature control
Flicker free function
Smooth dimming function
Halogen simulation
CYM emulation

SAFETY

eyebolts for safety chains

IP 67 RATING PROTECTION (art. 1507 only)

POWER SUPPLY

Voltage range: 100-240VAC
Frequency range: 47-63Hz
Active Power factor: PF>0.91/230VAC, PF>0.98/120VAC
0.22A@230VAC, 0.38A@120V
Power: 45W

DMX CHANNELS

9CH mode, 5CH mode, 4CH mode

PHYSICAL

WxDxH: 185x155x125 mm - Weight: 2 Kg.



(art. 1507)



(art. 1506)

Parled 100/M

monochromatic

art. 1508: 100/M
art. 1509: 100/M DRS



TECHNICAL SPECIFICATIONS

SOURCE

n. 7 high power 5000K White LEDs
available 3000K, 4000K or 6000K white LEDs or
red, green, blue, amber LEDs

Total out lumen: 4000lm (white led 5000K)
Total light power: 34W

OPTIC

25° (32 mm lenses)
On request: narrow, wide 32 mm lenses

MANUAL TILT 360°

CONNECTIONS

Signal: 4pin IP 67 male-female connector (art. 1509 only)
3x1mm 1.5mt cable

SETUP AND CONFIGURATION (art. 1509 only)

Remote configuration by DRS Setup device
Intelligent temperature control
Flicker free function
Smooth dimming function
Halogen simulation

SAFETY

eyebolts for safety chains

IP 67 RATING PROTECTION

POWER SUPPLY

Voltage range: 100-240VAC
Frequency range: 47-63Hz
Active Power factor:
PF>0.90/230VAC, PF>0.98/120VAC
Current:
0.2A@230VAC, 0.3A@120V
Power: 38W

DMX CHANNELS (art. 0509 only)

3CH mode, 1CH mode

PHYSICAL

WxDxH: 185x155x125 mm - Weight: 2 Kg.



(art. 1509)

Parspot 100

monochromatic

art. 1512



TECHNICAL SPECIFICATIONS

SOURCE

n. 19 (5000K White LEDs)
available 3000K, 4000K or 6000K white LEDs or
red, green, blue, amber LEDs

Total out lumen: 6000lm (white led 5000K)
Total light power: 60W

OPTIC

15° (38 mm lenses)
On request: middle, wide 38 mm lenses

MANUAL TILT 360°

CONNECTIONS

3x1mm 1.5mt cable

SAFETY

n. 2 eyebolts for safety chains

IP 67 RATING PROTECTION

POWER SUPPLY

Voltage range: 100-240VAC
Frequency range: 47-63Hz
Active Power factor:
PF>0.94/230VAC, PF>0.98/120VAC
Current:
0.32A@230VAC, 0.56A@120V
Total power: 70W

PHYSICAL

WxDxH: 268x100x240mm
Weight: 5,5 Kg.

Parled 200/WB

white balance

art. 1511



TECHNICAL SPECIFICATIONS

SOURCE

n. 16 3000K warm white LEDs
n. 16 5000K cold white LEDs
Total out lumen: 11.000lm (6.000 cold white + 5.000 warm white)
Total light power: 105W

On request:
n. 32 (3000K, 4000K, 5000K, 6000K white LEDs or red, green, blue, amber LEDs)

OPTIC

25° (38 mm lenses)
On request: narrow, wide 38 mm lenses

MANUAL TILT 240°

CONTROL

Standard interface: RS-485
Protocol: USITT DMX512

CONNECTIONS

Signal: XRL 5pin (on request 3pin) connector (male-female)
possibility to link up to 32 devices in chain
Available as accessories:
- Wireless DMX receiver
Main Power: POWERCON 3pin connector (male-female)
possibility to link up to 12 devices at 230V or 6 devices at 120V in chain.

CONTROL

Control panel with 4 push buttons
LED display with flip function
Dedicated DMX channel for white balance
DMX or automatic mode with MASTER/SLAVE function
Intelligent temperature control
Flicker free function
Smooth dimming function
Halogen simulation
Remote configuration by DRS Setup device

SAFETY

eyebolts for safety chains

POWER SUPPLY

Voltage range: 100-240VAC
Frequency range: 47-63Hz
Active Power factor:
PF>0.95/230VAC, PF>0.98/120VAC
Current:
0.55A@230VAC, 0.95A@120V
Power: 120W
Fuse T3.15A (inside fixture)

DMX CHANNELS

4CH mode, 2CH mode, 1CH mode

PHYSICAL

WxDxH: 330x212x364 (max) mm - Weight: 6,5 Kg.

WS 100

white

art. 1535



TECHNICAL SPECIFICATIONS

SOURCE

n. 24 (5000K White LEDs)
available 3000K, 4000K or 6000K white LEDs or
red, green, blue, amber LEDs

Total out lumen: 5000lm (white led 5000K)
Total light power: 36W

OPTIC

120°

MANUAL TILT 230°

CONNECTIONS

3x1mm 1.5mt cable

SAFETY

eyebolts for safety chains

IP 67 RATING PROTECTION

POWER SUPPLY

Voltage range: 100-240VAC
Frequency range: 47-63Hz
Active Power factor:
PF>0.96/230VAC, PF>0.99/120VAC
Current:
0.18A@230VAC, 0.35A@120V
Total power: 40W

PHYSICAL

WxDxH: 240x53x323mm
Weight: 2,7 Kg.

M-Terra

RGBW full color . monochromatic

art. 1440: TL1/FC
art. 1441: TL1/M

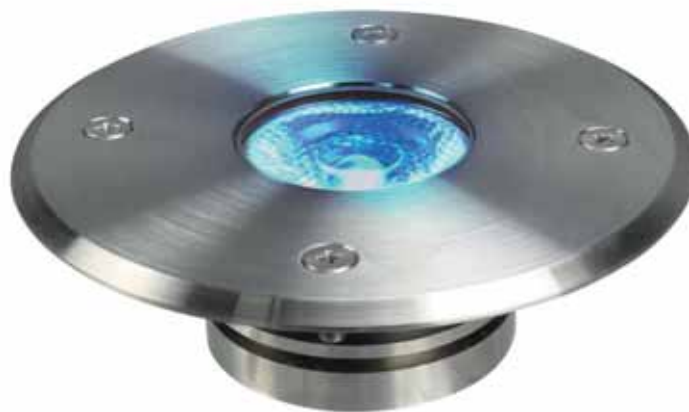

TECHNICAL SPECIFICATIONS

SOURCE

n.1 RGBW LED
Red 35lm, Green 80lm, Blue 16lm, White 80lm

OPTIC

25° (45 mm lenses)
On request: narrow, wide, elliptic 45 mm lense

POWER SUPPLY (not included)

Electric power: 7,5 W
Voltage: 6,7 VDC
Voltage range: 100-240VAC

MATERIAL / IP RATING PROTECTION

housing and trim ring in stainless steel
thermal-shock resistant tempered safety glass
IP 67 rating protection
On request: IP 68 rating protection

PHYSICAL

ØxH: 62x55 mm (ø 129 with trim ring)
Weight: 1 Kg.



M-Aria

RGBW full color . monochromatic

art. 1540: AL1/FC
art. 1541: AL1/M



TECHNICAL SPECIFICATIONS

SOURCE

n.1 RGBW LED
Red 35lm, Green 80lm, Blue 16lm, White 80lm

OPTIC

25° (45 mm lenses)
On request: narrow, wide, elliptic 45 mm lense

POWER SUPPLY (not included)

Electric power: 7,5 W
Voltage: 6,7 VDC
Voltage range: 100-240VAC

MATERIAL / IP RATING PROTECTION

housing in stainless steel
thermal-shock resistant tempered safety glass
IP 67 rating protection
On request: IP 68 rating protection

PHYSICAL

ØxH: 62x97,5 mm
Weight: 0,9 Kg.

▣ Architectural

▣ Monochromatic

▣ Showlighting

architectural meets showlighting
=
architainment





Studio Due

emotion and creativity in light



Headquarters:

STUDIO DUE light s.r.l.

Str. Poggino, 100 - 01100 Viterbo (Italy)
tel. +39.0761.352520 (4 lines)
fax +39.0761.352653
info@studiodue.com

STUDIO DUE UK

3 Encon Court, Owl Close
Moulton Park Industrial Estate
Northampton (England) UK - NN3 6 HZ
tel. +44.1933.650.820

STUDIO DUE Far East LTD

Unit 8, 4/F, Harbour Centre Tower II,
8 Hok Cheung Street,
Hungghom, Kowloon (Hong Kong)
tel. +852.29542141 fax +852.23302515

www.studiodue.com

