

Studio Due[®]

emotion and creativity in light

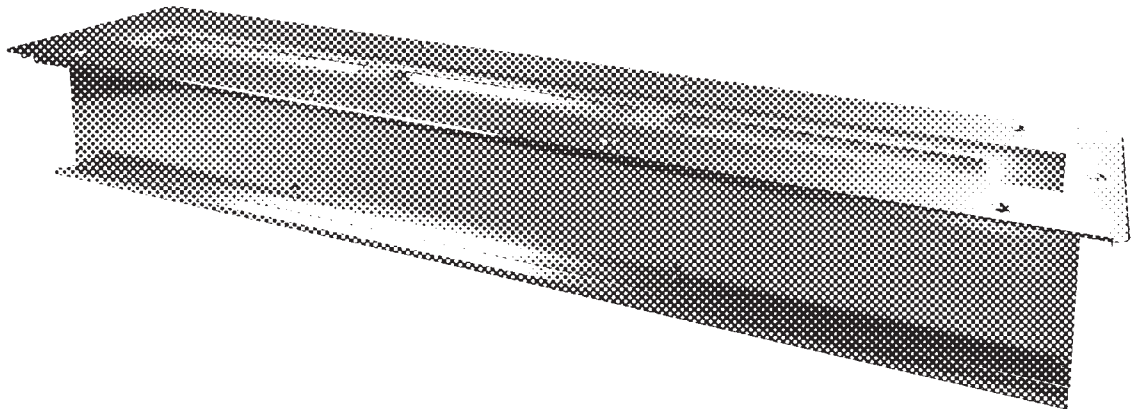

Archibar_i RDM
INTEGRATED

RGBW
Monochromatic
White balance

User manual for art. 1850-1852-1854-18541-1930
Manuale d'uso per art. 1850-1852-1854-18541-1930

this page is intentionally left blank / questa pagina è stata lasciata intenzionalmente bianca

4 PIN connector - Connettore 4 PIN



In this connector you can find the NUMBER 4 or the GROUND sign.

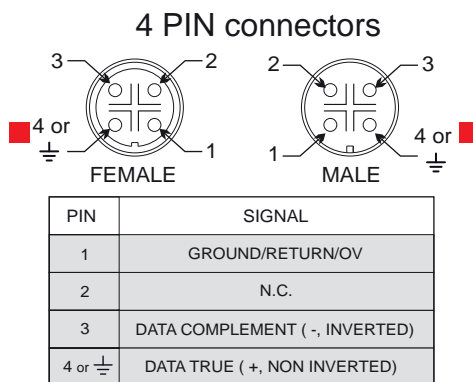

**WARNING
IMPORTANTE**

In questo connettore potete trovare il NUMERO 4 o il simbolo della TERRA.

IMPORTANTE **WARNING**

endowed with the fixture - incluso nell'apparecchio

If you want to connect the fixtures for **OUTDOOR** use, you can make a new cable utilizing the **art. 4 PIN-CONN M/F**

The cable is not endowed with the connectors kit

art. 4 PIN-CONN M/F



Se volete utilizzare gli apparecchi all'**ESTERNO**, potete realizzare dei nuovi cavi con **art. 4 PIN-CONN M/F**

Il cavo non è incluso nel kit dei connettori

optional - opzionale



**art. 4 PIN/XLR MF
(OPTIONAL)**

**these
CONNECTORS
are for INDOOR use
only**

questi connettori sono solo per uso INTERNO

INDOOR USE ONLY

art. 4 PIN/XLR MF male/female connectors
(optional)

art. 4 PIN/XLR MF connettori maschio/femmina
(opzionale)

**these
CONNECTORS
are IP67**

questi connettori sono IP67

IMPORTANT BEFORE MOUNTING / IMPORTANTE PRIMA DEL MONTAGGIO

⚠ NOT SUITABLE FOR VEHICLES
NON CARRABILE

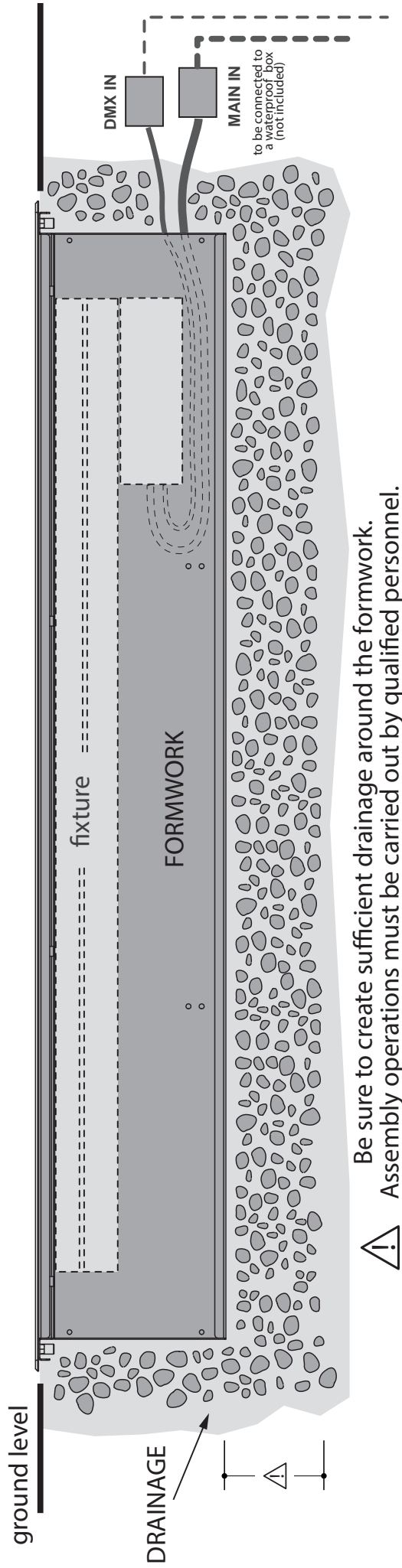

⚠ Be sure to create sufficient drainage around the formwork.
Assembly operations must be carried out by qualified personnel.

INDEX

Page 4 - Safety informations / Informazioni di sicurezza

Page 5 - Introduction / Introduzione

Page 6 - Technical features / Caratteristiche tecniche

Page 7 - Example of connection DMX controller-fixtures / Esempio di collegamento centralina DMX-fari

Page 8 - Main supply connection / Collegamento fonte di alimentazione

Page 9 - DMX signal connection / Collegamento segnale DMX

Page 10 - Setup and configuration of DRS Setup - Configurazione del DRS Setup

Page 12 - Menu list / Lista menu

Page 13 - DMX Listing / Lista dei canali DMX

Page 16 - Physical / Dimensioni

Page 17 - CE standards / Certificazioni CE

Page 19 - Warranty / Garanzia



**WARNING****SAFETY INFORMATION (service personnel)**

READ ALL CAUTIONS AND WARNINGS PRIOR TO OPERATE THIS EQUIPMENT.
INSTRUCTION TO PREVENT INJURY OR DAMAGE DUE TO ELECTRIC SHOCK, FIRE, MECHANICAL HAZARDS,
DANGEROUS MATTERS.

•PROTECTION AGAINST DANGEROUS MATTERS

At the end of its life, must be collected separately. It shouldn't be thrown as urban waste and neither released in the environment.

It must be collected from the nearest special waste collection point or consigned to your dealer that provides the service. The incorrect waste disposal can damage the environment and the people for the presence of dangerous substances. Sanctions are provided for an unauthorized disposal.

•PROTECTION AGAINST FIRE

- 1) Maintain minimum distance of 0,1 meter to lighted objects.
- 2) Replace fuses (if present) only with the specified type and rating.
- 3) Do not install the fixture close to heat sources. Do not lay the connection cable on the fixture when it is warm.
- 4) Fixture designed to be installed on normally flammable surfaces.

•PROTECTION AGAINST ELECTRIC SHOCK

- 1) **This equipment must be earthed.**
- 2) Class I equipment. The power supply cord includes a protective earthing conductor as part of the cord.
- 3) Disconnect power before servicing (service personnel).
- 4) To replace the LEDs, contact: Studio Due Trade Srls.
- 5) If the external flexible cable of this appliance is damaged, it must only be replaced by the manufacturer, its assistance service, or equivalent qualified personnel, in order to avoid dangers.

•PROTECTION AGAINST MECHANICAL HAZARDS

- 1) The protection screens and the lenses must be replaced with genuine parts only if they are visibly damaged and their effectiveness has been reduced, for example, by cracks or deep scratches.
- 2) Do not look directly into the illuminated LEDs of the product for long periods of time. LED lamps can cause eye damage or irritation. Do not look directly into the light source using an optical instrument that focuses on the light beams.

The device should be positioned so that there is no prolonged observation of the device at a distance of less than 100cm. (RG1 – IEC/TR 62778:2014).



IK10

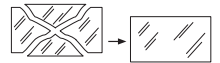

CE

**IMPORTANTE****INFORMAZIONI DI SICUREZZA (personale di servizio)**

LEGGERE ATTENTAMENTE TUTTI GLI AVVERTIMENTI PRIMA DI COMPIERE QUALUNQUE OPERAZIONE SU QUESTO APPARECCHIO. ISTRUZIONI PER PREVENIRE LESIONI O DANNI DOVUTI AL FUOCO, ALLE SCOSSE ELETTRICHE, AI RISCHI MECCANICI ED A SOSTANZE PERICOLOSE.

•PROTEZIONE CONTRO SOSTANZE PERICOLOSE

A fine vita è oggetto di raccolta separata, non gettare nei comuni cassonetti di rifiuti urbani, né tantomeno nell'ambiente. Può essere consegnato presso gli appositi centri di raccolta differenziata predisposti dalle amministrazioni comunali, oppure presso i rivenditori che forniscono questo servizio. Lo smaltimento errato può causare danni alle persone e all'ambiente per la possibile presenza di sostanze pericolose. Sono previste sanzioni in caso di smaltimento abusivo dei suddetti prodotti.

•PROTEZIONE CONTRO IL FUOCO

- 1) Mantenere la distanza minima di 0,1 metri dagli oggetti illuminati.
- 2) Sostituire i fusibili (se presenti) solo con altri dello stesso tipo e valore.
- 3) Non installare il faro vicino fonti di calore. Non appoggiare il cavo di connessione sul faro quando questo è caldo.
- 4) Questo apparecchio è adatto per il montaggio su superfici normalmente incombustibili.

•PROTEZIONE CONTRO SCOSSE ELETTRICHE

- 1) **Questo apparecchio necessita di messa a terra.**
- 2) Apparecchio di Classe I. Il conduttore di protezione deve far parte del cavo di alimentazione.
- 3) Disconnettere l'alimentazione prima di aprire l'apparecchio (personale di servizio).

•PROTEZIONE CONTRO RISCHI MECCANICI

- 1) Gli schermi di protezione e le lenti devono essere sostituiti sempre con ricambi originali se sono visibilmente danneggiati e se la loro efficacia è stata ridotta, per esempio, da fessure o incisioni profonde.
- 2) Non guardare direttamente nei LED illuminati del prodotto per lunghi periodi di tempo. Le lampade a LED possono causare danni o irritazione agli occhi. Non guardare direttamente nella sorgente luminosa utilizzando uno strumento ottico che si concentra sui fasci di luce. L'apparecchio dovrebbe essere posizionato in modo che non sia prevista un'osservazione prolungata dell'apparecchio ad una distanza inferiore di 100cm. (RG1 – IEC/TR 62778:2014).



IK10



CE



INTRODUCTION

Thanks for using Archibar SL150-inground RDM.

The ARCHIBAR SL150-i (INGROUND) RDM is equipped with 12 High Power LEDs.

Available in RGBW/FC and MONOCHROMATIC light source as well as in WHITE BALANCE and TILT 0-10° version.

INGROUND LED linear bar which combines aesthetic and resistance with ideal performanc in a versatile projector.

Waterproof and tremendously resistant.

NOT SUITABLE FOR VEHICLES.

- **Art. 1850 Archibar SL150-i RDM RGBW/FC** (full color)
- **Art. 1852 Archibar SL150-i RDM WB White Balance**
- **Art. 1854 Archibar SL150-i RDM M Monochromatic - DIMMABLE** (On request)
- **Art. 18541 Archibar SL150-i M Monochromatic - PLUG-IN**
- **Art. 1930 Archibar SL150-i T RDM RGBW/FC** (tilt version)

To obtain the best performances and for a correct functioning of this unit for the years to come, we suggest you to read carefully this manual before connecting or putting the fixture into use. By doing so you will gain experience with its commands and connections and you will be easily able to use it.

YOUR REFERENCE

Always remember to give the serial number and to specify the model any time you address the seller for information or assistance.

BASIC KIT

- Projector + formwork
- User manual
- Studio Due warranty
- CE standards

**WARNING**

Check that the fixture has not been damaged during transport. If it has been damaged or it does not work, address the seller. Whether the fixture has been shipped to you directly, please contact the shipping company. Only the consignee (person or company) can claim for these damages.

INTRODUZIONE

Vi ringraziamo per l'utilizzo del nostro Archibar SL150-inground RDM.

Archibar SL150-i (INGROUND) RDM è dotato di 12 potenti LEDs.

Disponibile in versione RGBW/FC, MONOCROMATICA e WHITE BALANCE e versione TILT 0-10°.

Barra lineare LED INGROUND che combina estetica e resistenza con prestazioni eccezionali in un proiettore versatile.

Impermeabile e altamente resistente.

NON CARRABILE.

- **Art. 1850 Archibar SL150-i RDM RGBW/FC** (full color)
- **Art. 1852 Archibar SL150-i RDM WB White Balance**
- **Art. 1854 Archibar SL150-i RDM M Monocromatico - DIMMERABILE** (A richiesta)
- **Art. 18541 Archibar SL150-i M Monocromatico - PLUG-IN**
- **Art. 1930 Archibar SL150-i T RDM RGBW/FC** (tilt version)

Per ottenere il meglio delle prestazioni ed un corretto funzionamento negli anni di questa unità, Vi consigliamo di leggere attentamente questo manuale prima di collegarla e metterla in uso. In questo modo acquisirete familiarità con i suoi comandi e collegamenti affinché possiate utilizzarla facilmente.

VOSTRA REFERENZA

Citate sempre il numero del modello e di serie ogni volta che Vi rivolgete al vostro rivenditore per informazioni o assistenza.

CONFEZIONE BASE

- Proiettore + cassaforma
- Manuale d'uso
- Garanzia Studio Due
- Dichiarazione CE

**IMPORTANTE**

Controllate che l'apparecchio non abbia subito alcun danno durante il trasporto.

Se avesse subito dei danni o se non dovesse funzionare, rivolgetevi al vostro rivenditore.

Se l'apparecchio vi è stato spedito direttamente, rivolgetevi subito alla ditta di trasporto.

Solo il destinatario (la persona o ditta ricevente l'apparecchio) può reclamare per questo tipo di danni.

TECHNICAL FEATURES / CARATTERISTICHE TECNICHE



• SOURCE

n. 12 (5050-20W-RTBH) LEDs
Total out lumen: R 750, G 1800, B 300, W 1700
Total light power: 40W

• OPTIC

25° (38 mm lenses)
On request: 8°, 15°, 40°, 60° or 10°x30° beam

• TILT (only for art. 1930)

motorized 0° - 10° (with optional DRS setup-Tilt)

• CONTROL

Standard interface: RS-485
Protocol: USITT DMX 512 / RDM

• CONNECTIONS

Signal: 3pin cable 70cm. (could be wired with 4PIN connector)
possibility to link up to 32 devices in chain

Available as accessories:

- Wireless DMX receiver

Main Power: 3pin cable 70cm.

possibility to link up to 8 devices at 230V or
4 devices at 120V in chain.

• SETUP AND CONFIGURATION

RDM Control/configuration or
individually by DRS (remote control device)

> Only art. 1930: optional DRS Setup-Tilt

Dedicated DMX channel for white balance

DMX or Auto mode with Master-Slave function

Intelligent temperature control

Halogen simulation

CYM simulation

Flicker-free function

Smooth dimming function

• IP67 RATING PROTECTION

• IK10 RATING

• POWER SUPPLY

Voltage range: 100-240VAC

Frequency range: 47-63Hz

Active Power factor:

PF>0.97@230VAC

Current: 0.2A@230VAC

Power: 45W

Fuse T3,15A (inside fixture)

• DMX CHANNELS

9CH mode, 6CH mode, 5CH mode, 4CH mode

• PHYSICAL

WxDxH: 1063x182x133 mm

Weight: 15 Kg.



warm neutral cool



2700K 6500K

• SOURCE

n. 24 warm, neutral, cool LEDs monochromatic

n. 12 (2700K) + 12 (6500K) white balance

On request: red, green, blue or amber

Total out lumen: 48W (monochromatic) - 40W (white balance)

Total out power: 7500 (monochromatic) - 6000 (white balance)

• OPTIC

20°x30° (38 mm lenses)

On request: narrow, medium, wide or 30°x50° beam

• CONTROL

Standard interface: RS-485

Protocol: USITT DMX 512 / RDM

• CONNECTIONS

Signal: 3pin cable 70cm.

possibility to link up to 32 devices in chain

Available as accessories:

- Wireless DMX receiver

Main Power: cable 70cm.

possibility to link up to 8 devices at 230V or
4 devices at 120V in chain.

• SETUP AND CONFIGURATION

RDM Control/configuration or

individually by DRS (remote control device)

Dedicated DMX channel for white balance

DMX or Auto mode with Master-Slave function

Intelligent temperature control

Halogen simulation

CYM simulation

Flicker-free function

Smooth dimming function

• IP67 RATING PROTECTION

• IK10 RATING

• POWER SUPPLY

Voltage range: 100-240VAC

Frequency range: 47-63Hz

Active Power factor:

PF>0.97/230VAC

Current: 0.28A@230VAC

Power: 55W (monochromatic) - 45W (white balance)

Fuse T3,15A (inside fixture)

• DMX CHANNELS

4CH mode, 2CH mode, 1CH mode (white balance)

3CH mode, 1CH mode (monochromatic)

• PHYSICAL

WxDxH: 1063x182x133 mm

Weight: 15 Kg.

For PLUG IN version

- Main Power: cable 70cm.

- NO CONTROL

- NO SETUP and CONFIGURATION

- NO DMX CHANNELS

EXAMPLE OF CONNECTION DMX CONTROLLER - FIXTURES / ESEMPIO DI COLLEGAMENTO CENTRALINA - FARI

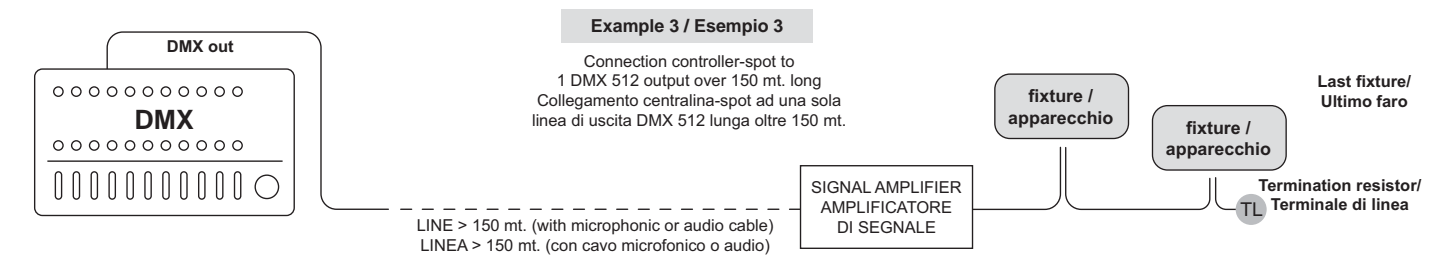
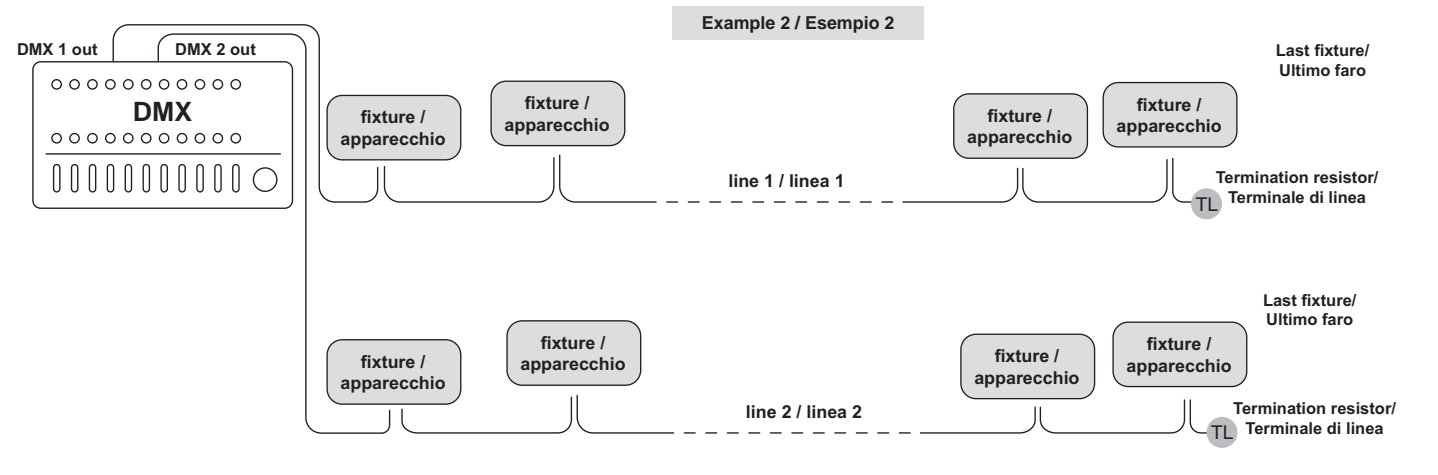
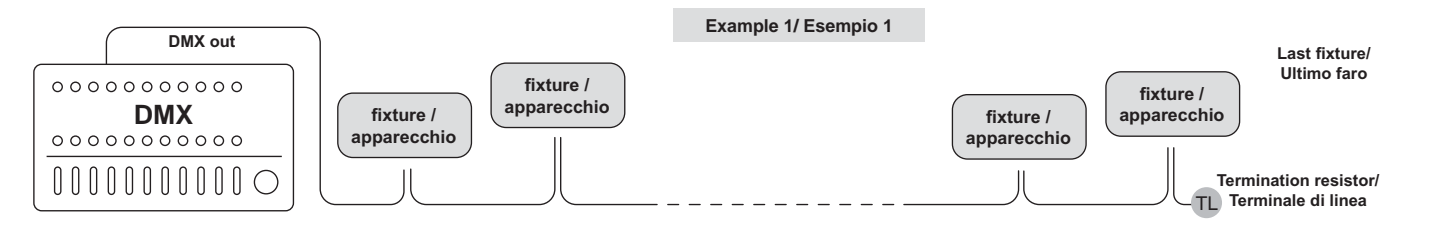

NORMAL AND MASTER/SLAVE FUNCTIONS / FUNZIONI NORMAL E MASTER/SLAVE

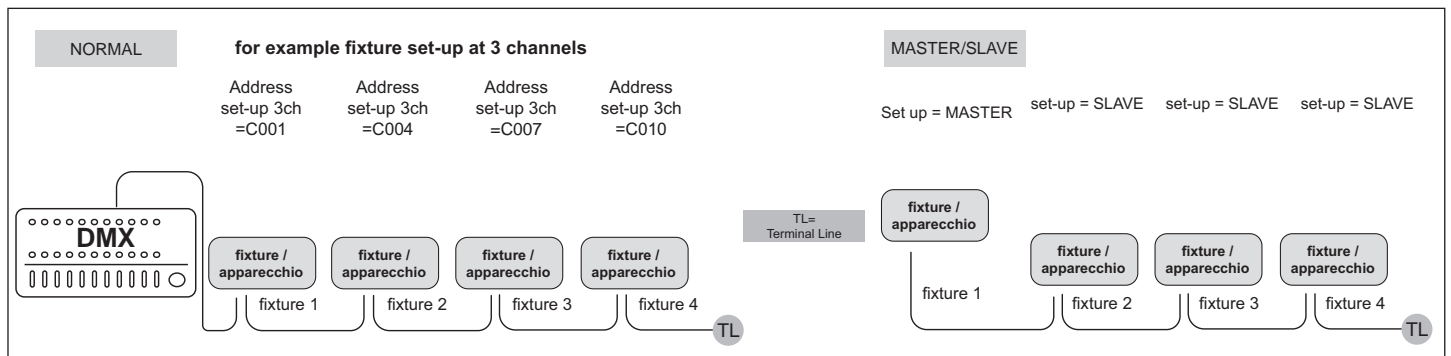

CONNECTION TO THE MAIN POWER / CONNESSIONE ALLA RETE ELETTRICA

eng

This equipment must be earthed.
 Class I equipment. The power supply cord includes a protective earthing conductor as part of the cord.
IMPORTANT: to ensure the IP67 protection rating, in case of replacement of the conductor cable, refer to the CONDUCTOR SIZE TABLE

ita

Questo apparecchio necessita di messa a terra.
 Apparecchio di Classe I. Il conduttore di protezione deve far parte del cavo di alimentazione.
IMPORTANTE: per garantire il grado di protezione IP67, in caso di sostituzione del cavo di alimentazione, fare riferimento alla TABELLA SEZIONE CONDUTTORE.

! WARNING

HIGH VOLTAGE!
Always disconnect the mains supply before access to the connection area.

ALTA TENSIONE!
Scollegare sempre l'alimentazione prima di aprire il vano dei collegamenti.

Per accedere all'interno della cassaforma svitare le 10 viti poste nella flangia in acciaio.

To access inside the formwork, unscrew the 10 screws placed in the steel flange.

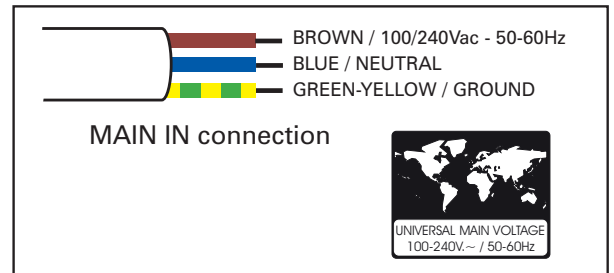
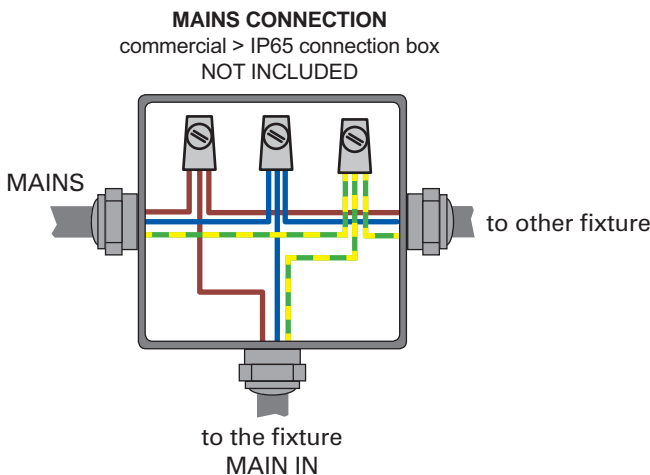
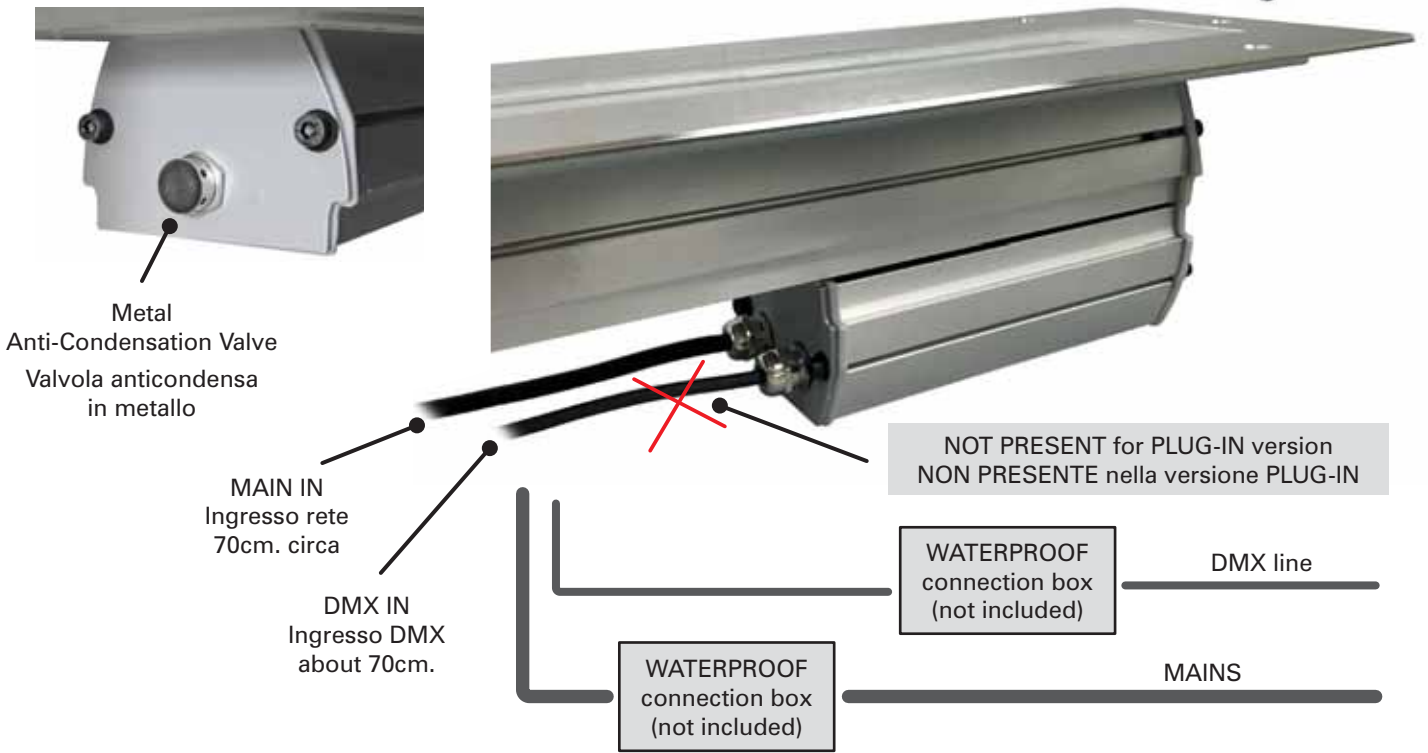

**POWER INPUT/
 INGRESSO ALIMENTAZIONE Ø 6 - 12mm**

CONDUCTOR SIZES / SEZIONE CONDUTTORE (length / lunghezza < 20mt.)	
MAINS VOLTAGE	CROSS SELECTIONAL AREAS
230V	3X1 mm ² (minimum)

eng

DMX TERMINAL LINE

The wrong connection of the terminal line or its non-connection are probably the most frequent reasons for the defective functioning of the DMX line. The terminator is a terminal resistor fitted at the end of the cable furthest from the transmitter. The terminal resistor should have the same value as the impedance of the connection cable. We suggest to use a terminal with a 120 Ohm resistor. It is recommended that all DMX 512 systems have the terminal resistor fitted in the DMX output of the last fixture.

ita

TERMINALE LINEA DMX

L'incorretto o il mancato collegamento del terminale di linea è probabilmente la più comune causa del difettoso funzionamento della linea DMX. Il terminale di linea DMX consiste in una resistenza posta alla fine della linea. La resistenza terminale dovrebbe avere idealmente lo stesso valore dell'impedenza del cavo di collegamento. Noi consigliamo di usare come terminale una resistenza da 120 Ohm. E' raccomandato per tutti i sistemi DMX 512 inserire il terminale di linea nel connettore uscita DMX dell'ultimo apparecchio collegato.

example of label on the rear of the fixture

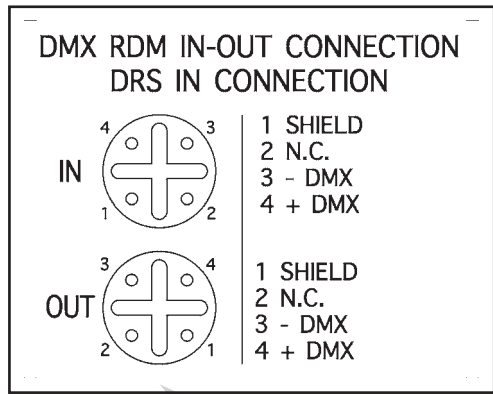

label for fixture without TILT ADJUSTMENT

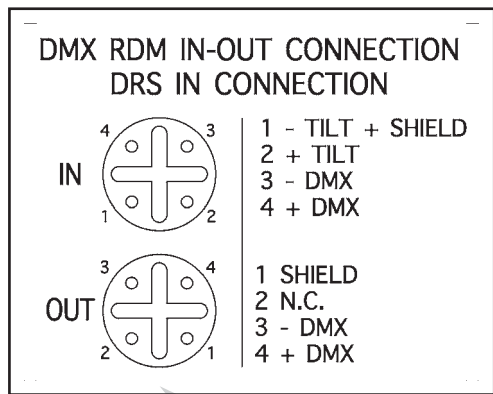
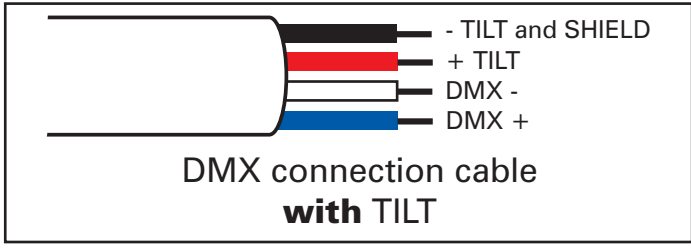
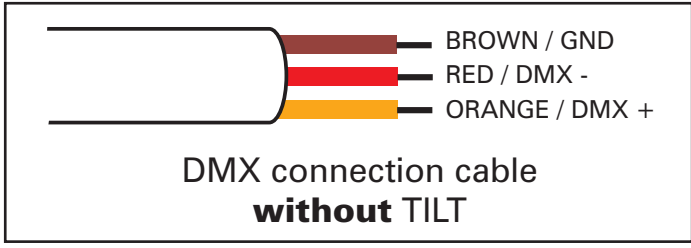

label for fixture with TILT ADJUSTMENT

NOTE:
these DMX cables (3 or 4 wire) could be already wired with 4PIN connector to allow TILT ADJUSTMENT with DRS Setup-T.
Questi cavi DMX potrebbero essere già cablati con il connettore 4PIN per consentire la REGOLAZIONE TILT con il DRS Setup-T.



SETUP and CONFIGURATION by DRS - DMX REMOTE SETUP
SETTAGGIO e CONFIGURAZIONE tramite DRS - DMX REMOTE SETUP

eng

The DRS it's a new concept of professional LED Lighting fixtures suitable for outdoor permanent installations. The LED Lighting fixtures can be driven via DMX through a specific electronic device, the DRS DMX Remote Setup, that grant the possibility to set up the scenarios and the games remotely. These LED Lighting fixtures have installed on board a series of programs including the stand alone function.

The DRS is a simple set up commander that linked with the DMX input of a LED Lighting fixture allow to program all the functions of the luminaire.

It's than possible to assign the DMX channel or use the Master/Slave function.

The device is powered through battery.

ita

DRS è il nuovo concetto dell'illuminazione LED per uso professionale nelle installazioni esterne permanenti.

Gli apparecchi LED possono essere controllati e configurati tramite uno specifico controller: il DRS, DMX Remote Setup, il quale consente di programmare e configurare scene e giochi di luce in modalità remota.

Questi apparecchi LED hanno installati a bordo una serie di giochi che includono la funzione stand alone.

Il DRS, DMX Remote Setup, è un semplice set-up commander che collegato via DMX ad un'apparecchio consente la sua programmazione e configurazione.





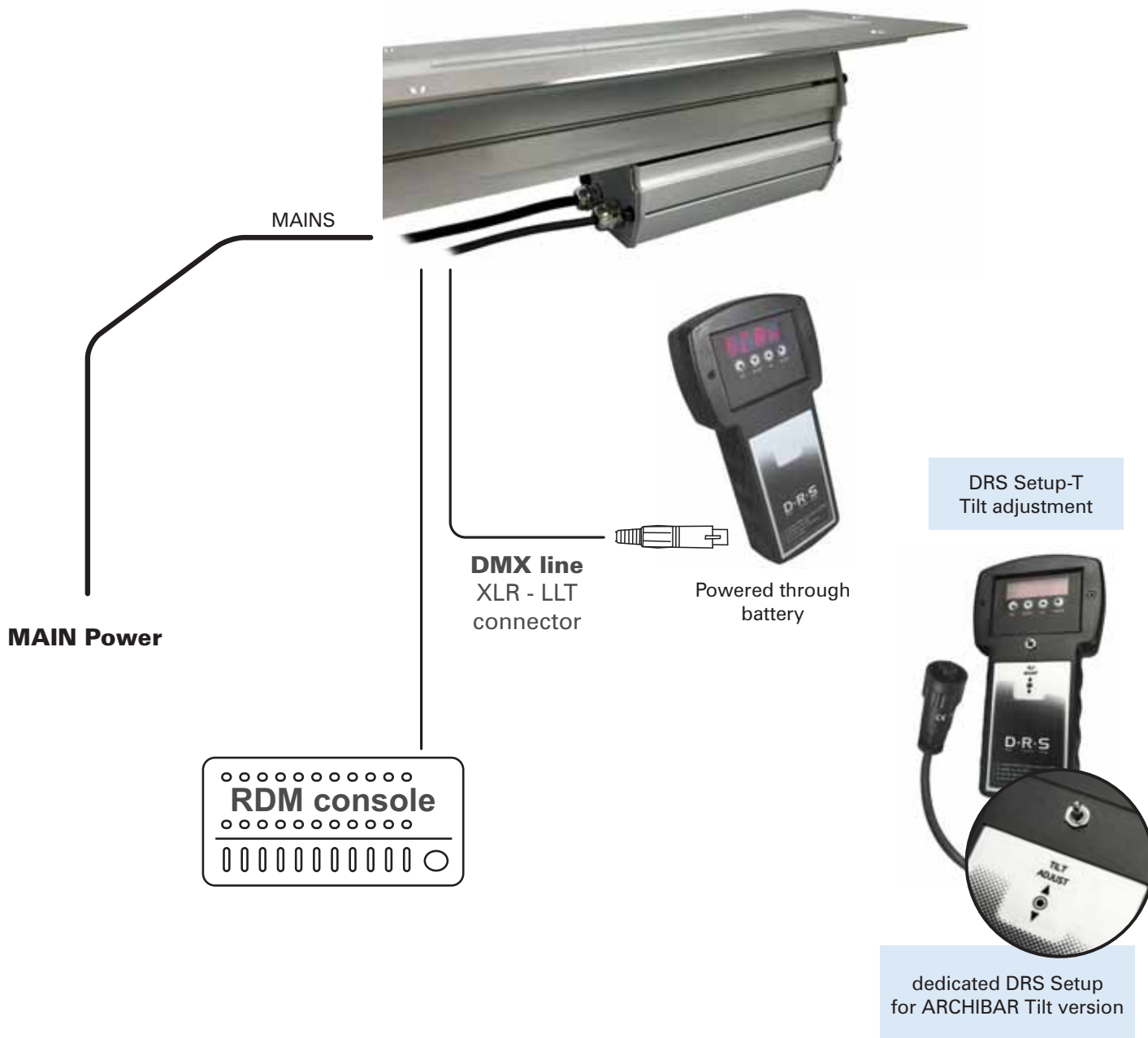

E' possibile assegnare agli apparecchi collegati i canali DMX o utilizzzare la funzione Master/Slave.

Il DRS è alimentato a batterie.



Dedicated DRS (DMX Remote Setup) FUNCTIONING with or without TILT ADJUSTMENT

To make the set-up of the various fixture parameter, proceed as follow:

- Disconnect the fixture to set-up from the other DMX/RDM devices
- Connect the DMX cable of the fixture to the DRS commander
-  Switch on the DRS commander (Press any button) and wait for the **8888** sign
-  If the DRS commander detects a compatible DRS device, displays shortly the **Conn** written and afterwards, displays the name of the fixture and its software version.
-  If the DRS commander don't detects any compatible DRS device or is present any malfunction, the display shows the **SCAn** written
-  When the detection sequence is finished, the display shows the first menu
-  The UP/DOWN buttons allow to scroll forward/backward the menu list
-  The ENTER button allow to confirm the selected option (if the parameter is flashing)
-  The ESC button allow to delete the operation and return to a previous menu level



DRS Setup







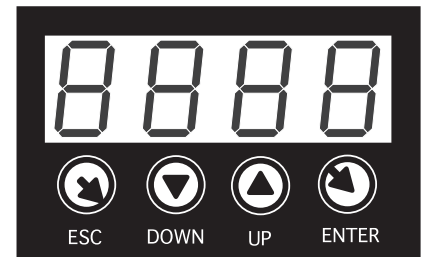

DRS Setup-Tilt

The DRS SETUP-T device
(for ARCHIBAR with TILT ADJUSTMENT)
can also be used for
ARCHIBAR with STATIC OPTIC
(ignore the TILT function)

Il dispositivo DRS SETUP-T
(per ARCHIBAR con REGOLAZIONE TILT) può
essere utilizzato anche per
ARCHIBAR con STATIC OPTIC
(ignorare la funzione TILT)

**FUNZIONAMENTO DI BASE DEL DRS dedicato (DMX remote Setup) con o senza REGOLAZIONE del TILT**















Per effettuare la programmazione dei vari parametri di un apparecchio, è necessario procedere come segue:

- Disconnettere l'apparecchio da configurare da altri dispositivi DMX/RDM
- Collegare il cavo DMX dell'apparecchio da configurare, al programmatore DRS
-  Accendere il programmatore DRS (premere qualsiasi pulsante) ed attendere che si visualizzi la scritta **8888**
-  Se il programmatore DRS individua un dispositivo DRS compatibile, visualizza per qualche istante la scritta **Conn** e, successivamente, visualizza il nome dell'apparecchio e la relativa versione software
-  Se il programmatore DRS non individua alcun dispositivo DRS compatibile o è presente qualche malfunzionamento il display visualizzerà la scritta **SCAn**
-  Una volta terminata la sequenza di riconoscimento, viene visualizzato il primo menu dell'apparecchio
-  I pulsanti UP/DOWN permettono di scorrere la lista dei menu
-  Il pulsante ENTER permettere di entrare in un menu o di confermare una opzione in caso di lampeggio del parametro
-  Il pulsante ESC annulla una operazione o torna al livello di menu inferiore.

DRS MENU' LIST ELENCO MENU'DRS

Switching on the fixture you can see the model and the software version. For example:
All'accensione, viene visualizzato il modello di apparecchio e la versione software. Per esempio:

--> Archibar 150 rGbU RDM --> 1_00
than it's shown the fist menu
poi viene visualizzato il primo menu

Address (Addr)		Imposta l'indirizzo DMX Set the DMX address
Auto Mode (ModE)		Imposta la modalità DMX, SLAVE o MASTER Set the DMX, SLAVE or MASTER mode (no, SL, Pr01...Prxx)
Auto Speed (PrSP)		Imposta la velocità di esecuzione dei giochi interni Set the preset execution speed (-400%...+400%)
Wireless enable (ULEn)		Enable or disable the wireless reception Consente o non consente la ricezione wireless (ON / OFF) The cable reception is disabled / La ricezione via cavo viene disabilita
Wireless unlink (ULPA)		Remove the link from the fixture to the associated transmitter (PA?) Elimina il link tra l'apparecchio e il trasmettitore al quale è stato associato
Wireless bridge (ULbr)		If wireless is ON, enable the transmission of the received data by cable to the other fixtures / Se il wireless è attivo, consente la trasmissione dati agli altri apparecchi collegati via cavo. (ON / OFF)
N. Channels (nChn)		Imposta il numero di canali DMX dell'apparecchio Set the DMX channels of the fixture (9, 6, 5, 4)
Flicker free function (FLCr)		from 2.09 software version / dalla versione software 2.09 Select the value f1 .. f2 Selezionate il valore desiderato f1 .. f2
Smooth Dimming (SMth)		Imposta il tipo di interpolazione per la funzione smooth dimming Set the interpolation type for the smooth dimming function (OFF, Sd1, Sd2, Sd3)
Halogen Simulation (HALS)		Imposta il funzionamento della modalità simulazione lampada alogena Set the alogen simulation function mode (OFF, Mod1, Mod2)
CYM Emulation (CYMS)		Imposta l'apparecchio per funzionare come emulatore di sistema CYM o RGB Set the fixture to work in CYM or RGB emulation system (OFF -->RGBW, On -->CYM)
Test (tEst)		Abilita il test dell'apparecchio ed esegue un programma di fabbrica per verificarne il funzionamento Enables the test of the fixture and execute a factory program to check the right functioning (OFF, On)
Reset (rSEt)		Esegue un reset della parte elettronica Execute a reset of the electronic section
Format (FrMt)		Ripristina le impostazioni di fabbrica (Viene chiesta conferma) Restore the factory setting (Require confirmation)

DMX Channels list 9Ch / Lista dei canali DMX 9Ch

8 BIT	FUNCTION	0 31 63 95 127 159 191 233 255
CH1	RED	
CH2	GREEN	
CH3	BLUE	
CH4	WHITE	
CH5	STROBE	
CH6	DIMMER	
CH7	LED FADE TIME	
CH8	RAINBOW	
CH9	BALANCED WHITE	

DMX Channels list 6Ch / Lista dei canali DMX 6Ch

8 BIT	FUNCTION	0 31 63 95 127 159 191 233 255
CH1	RED	
CH2	GREEN	
CH3	BLUE	
CH4	WHITE	
CH5	DIMMER	
CH6	RAINBOW	

DMX Channels list 5Ch / Lista dei canali DMX 5Ch

8 BIT	FUNCTION	0 31 63 95 127 159 191 233 255
CH1	RED	
CH2	GREEN	
CH3	BLUE	
CH4	WHITE	
CH5	DIMMER	

DMX Channels list 4Ch / Lista dei canali DMX 4Ch

8 BIT	FUNCTION	0 31 63 95 127 159 191 233 255
CH1	RED	
CH2	GREEN	
CH3	BLUE	
CH4	WHITE	

WHITE BALANCE

DMX Channels list 4Ch / Lista dei canali DMX 4Ch

8 BIT	FUNCTION	<div style="text-align: center;"> 0 31 63 95 127 159 191 233 255 </div>
CH1	BALANCED WHITE	<div style="display: flex; align-items: center;"> <div style="margin-right: 10px;">(0-15) NORMAL</div> <div style="margin-right: 10px;">WW</div> <div style="flex-grow: 1; border: 1px solid black; border-radius: 10px; position: relative;"> <div style="position: absolute; top: -10px; left: 50%; transform: translate(-50%, -100%);">16-255</div> </div> <div style="margin-left: 10px;">CW</div> </div>
CH2	DIMMER	<div style="display: flex; align-items: center;"> <div style="width: 20px; height: 20px; background-color: black; border-radius: 50%; margin-right: 10px;"></div> <div style="flex-grow: 1; border: 1px solid black; border-radius: 10px; background: linear-gradient(to right, black, gray, white);"></div> <div style="width: 20px; height: 20px; border-radius: 50%; margin-left: 10px;"></div> </div>
CH3	STROBE	<div style="display: flex; align-items: center;"> <div style="margin-right: 10px;"> <input type="checkbox"/> OPEN 0-1 </div> <div style="flex-grow: 1; position: relative;"> <div style="position: absolute; top: -10px; left: 20%;">FLASH 0,4Hz / 25Hz 2-127</div> <div style="position: absolute; top: -10px; right: 20%;">RAINBOW - FLASH 0,4Hz / 25Hz 128-255</div> </div> </div>
CH4	LED FADE TIME	<div style="display: flex; align-items: center;"> <div style="margin-right: 10px;">FAST - 0,1 sec. 0 = CUT</div> <div style="flex-grow: 1; border: 1px solid black; border-radius: 10px; background: linear-gradient(to right, blue, cyan, green, yellow, orange, red);"></div> <div style="margin-left: 10px;">SLOW 25,5 sec.</div> </div>

DMX Channels list 2Ch / Lista dei canali DMX 2Ch

8 BIT	FUNCTION	<div style="text-align: center;"> 0 31 63 95 127 159 191 233 255 </div>
CH1	BALANCED WHITE	<div style="display: flex; align-items: center;"> <div style="margin-right: 10px;">(0-15) NORMAL</div> <div style="margin-right: 10px;">WW</div> <div style="flex-grow: 1; border: 1px solid black; border-radius: 10px; position: relative;"> <div style="position: absolute; top: -10px; left: 50%; transform: translate(-50%, -100%);">16-255</div> </div> <div style="margin-left: 10px;">CW</div> </div>
CH2	DIMMER	<div style="display: flex; align-items: center;"> <div style="width: 20px; height: 20px; background-color: black; border-radius: 50%; margin-right: 10px;"></div> <div style="flex-grow: 1; border: 1px solid black; border-radius: 10px; background: linear-gradient(to right, black, gray, white);"></div> <div style="width: 20px; height: 20px; border-radius: 50%; margin-left: 10px;"></div> </div>

DMX Channels list 1Ch / Lista dei canali DMX 1Ch

8 BIT	FUNCTION	<div style="text-align: center;"> 0 31 63 95 127 159 191 233 255 </div>
CH1	BALANCED WHITE	<div style="display: flex; align-items: center;"> <div style="margin-right: 10px;">(0-15) NORMAL</div> <div style="margin-right: 10px;">WW</div> <div style="flex-grow: 1; border: 1px solid black; border-radius: 10px; position: relative;"> <div style="position: absolute; top: -10px; left: 50%; transform: translate(-50%, -100%);">16-255</div> </div> <div style="margin-left: 10px;">CW</div> </div>

MONOCHROMATIC / MONOCROMATICO

DMX Channels list 3Ch / Lista dei canali DMX 3Ch

8 BIT	FUNCTION	<div style="text-align: center;"> 0 31 63 95 127 159 191 233 255 </div>
CH1	DIMMER	<div style="display: flex; align-items: center;"> <div style="width: 20px; height: 20px; background-color: black; border-radius: 50%; margin-right: 10px;"></div> <div style="flex-grow: 1; border: 1px solid black; border-radius: 10px; background: linear-gradient(to right, black, gray, white);"></div> <div style="width: 20px; height: 20px; border-radius: 50%; margin-left: 10px;"></div> </div>
CH2	STROBE	<div style="display: flex; align-items: center;"> <div style="margin-right: 10px;"> <input type="checkbox"/> OPEN 0-1 </div> <div style="flex-grow: 1; position: relative;"> <div style="position: absolute; top: -10px; left: 20%;">FLASH 0,4Hz / 25Hz 2-127</div> <div style="position: absolute; top: -10px; right: 20%;">RAINBOW - FLASH 0,4Hz / 25Hz 128-255</div> </div> </div>
CH3	LED FADE TIME	<div style="display: flex; align-items: center;"> <div style="margin-right: 10px;">FAST - 0,1 sec. 0 = CUT</div> <div style="flex-grow: 1; border: 1px solid black; border-radius: 10px; background: linear-gradient(to right, blue, cyan, green, yellow, orange, red);"></div> <div style="margin-left: 10px;">SLOW 25,5 sec.</div> </div>

DMX Channels list 1Ch / Lista dei canali DMX 1Ch

8 BIT	FUNCTION	<div style="text-align: center;"> 0 31 63 95 127 159 191 233 255 </div>
CH1	DIMMER	<div style="display: flex; align-items: center;"> <div style="width: 20px; height: 20px; background-color: black; border-radius: 50%; margin-right: 10px;"></div> <div style="flex-grow: 1; border: 1px solid black; border-radius: 10px; background: linear-gradient(to right, black, gray, white);"></div> <div style="width: 20px; height: 20px; border-radius: 50%; margin-left: 10px;"></div> </div>

PHYSICAL / DIMENSIONI

motorized tilt adjustment

$0^\circ + 10^\circ$

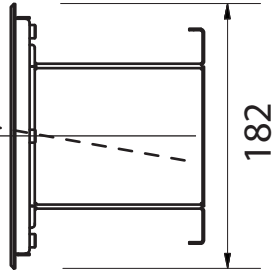
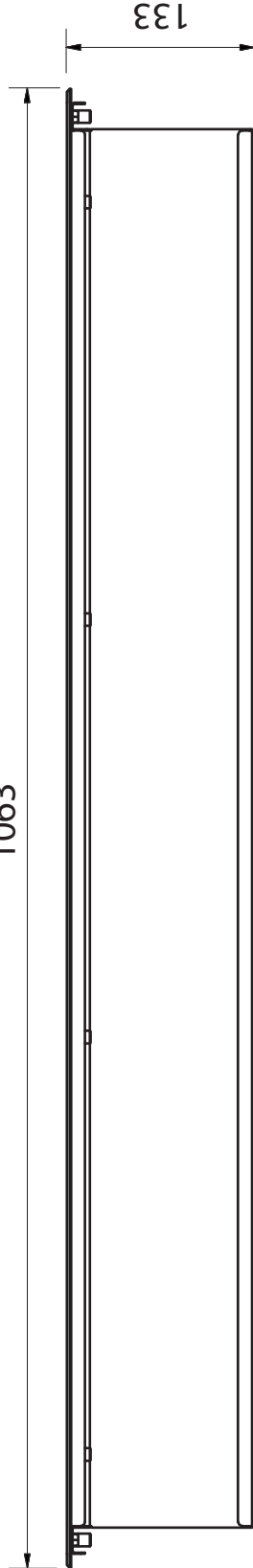

only for art. 1930

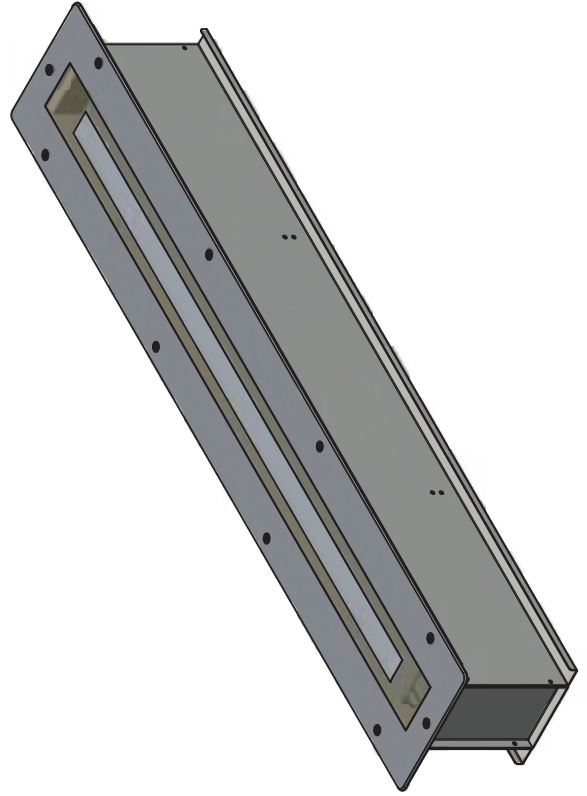
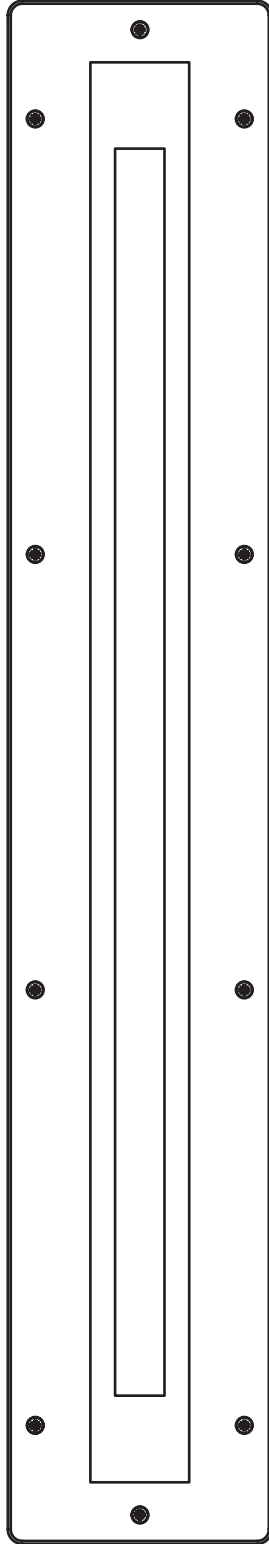

Dichiarazione CE di conformità

Declaration CE of conformity

La ditta: STUDIO DUE light s.r.l.
The firm: Strada Poggino, 100
01100 VITERBO
ITALY

dichiara sotto la propria responsabilità che il prodotto:
declare under our sole responsibility that the product:

ARCHIBAR SL150-i RDM RGBW/FC (inground) IP67 codice 1850
ARCHIBAR SL150-i T (tilt) RDM RGBW/FC (inground) IP67 codice 1930

è conforme alle norme: CE
is in conformity with the standard: CE

Low Voltage Directive: 2014/35/EU

EN 60529:1991 + A1:2000 + A2:2013
EN 62471:2008
EN 60598-1:2015
EN 60598-2-17:1989 + A2:1991

ECM Directive: 2014/30/EU

EN 61000-3-2:2014	EN 61000-4-2
EN 61000-3-3:2013	EN 61000-4-3
EN 61547:2009	EN 61000-4-4
EN 55103-2:2009	EN 61000-4-5
EN 55015:2013	EN 61000-4-6
EN 55103-1:2009 + A1:2012	EN 61000-4-11

e quindi ai requisiti essenziali delle Direttive:
and therefore according to essential requirement of Directives:

2004/108/EC – Electromagnetic compatibility
2006/95/EC – Low Voltage directive

Data di apposizione CE : 19
Date of CE marking :

VITERBO, 07/05/2019

PAOLO SENSI
General Manager

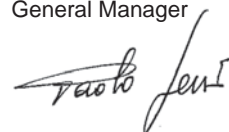

Dichiarazione **CE** di conformità

Declaration **CE** of conformity

CE 07/18

La ditta: STUDIO DUE light s.r.l.
The firm: Strada Poggino, 100
01100 VITERBO
ITALY

dichiara sotto la propria responsabilità che il prodotto:
declare under our sole responsibility that the product:

ARCHIBAR SL150-i RDM WB (White Balance) IP67 (inground) - codice 1852
ARCHIBAR SL150-i RDM M (Monochromatic dimmable) IP67 (inground) - codice 1854
ARCHIBAR SL150-i RDM M (Monochromatic plug-in) IP67 (inground) - codice 18541

è conforme alle norme: **CE**
is in conformity with the standard: **CE**

Low Voltage Directive: 2014/35/EU

EN 60529:1991 + A1:2000 + A2:2013
EN 62471:2008
EN 60598-1:2015
EN 60598-2-17:1989 + A2:1991

ECM Directive: 2014/30/EU

EN 61000-3-2:2014	EN 61000-4-2
EN 61000-3-3:2013	EN 61000-4-3
EN 61547:2009	EN 61000-4-4
EN 55103-2:2009	EN 61000-4-5
EN 55015:2013	EN 61000-4-6
EN 55103-1:2009 + A1:2012	EN 61000-4-11

e quindi ai requisiti essenziali delle Direttive:
and therefore according to essential requirement of Directives:

2004/108/EC – Electromagnetic compatibility
2006/95/EC – Low Voltage directive

Data di apposizione **CE** : 18
Date of **CE** marking :

VITERBO, 12/07/2018

PAOLO SENSI
General Manager

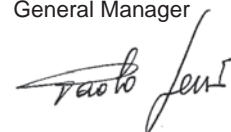

Warranty CARD

Company name:

Mr./Mrs./Miss:

Address:

Tel. or E-mail :

Dealer:

SALE CONDITIONS

1) Price quoted are not inclusive of lamp and package.
Package charge is 2% on the net price for all the items.
These prices should be subject to possible variations for eventual rises of production costs or duties.
Claims for possible damages during the freight, must be notified to the carrier.
Any claim must be notified within 8 days from the receipt of the goods.
The buyer is responsible of the right installation and use of the apparatus.
All the apparatuses are guaranteed for one year against defects of manufacture or materials.
Defects and breakages caused by wrong connection or use of the apparatuses are not subject to guarantee.
The lamp is excluded from the warranty.
For any dispute is competent the Tribunal of Viterbo.

CONDIZIONI DI VENDITA

1) I prezzi riportati sono esclusi di IVA, lampada ed imballaggio.
Il costo di imballaggio è del 2% sul prezzo netto per tutti gli articoli.
Detti prezzi possono essere soggetti a possibili variazioni per eventuali aumenti dei costi di produzione o imposte.
La merce viaggia a rischio e pericolo del committente, anche se in porto franco.
Reclami per possibili danni durante il trasporto, dovranno essere fatti esclusivamente al vettore.
Eventuali osservazioni sulle merci ricevute dovranno esserci notificate entro e non oltre 8 giorni dal ricevimento delle medesime.
Sui ritardi dei pagamenti verrà conteggiato l'interesse commerciale.
L'acquirente si impegna a comunicare la propria esatta ragione sociale e partita IVA al momento dell'ordine e sotto la propria responsabilità di verificarla in fattura.
L'acquirente è responsabile della corretta installazione ed uso delle apparecchiature.
Tutte le apparecchiature godono della garanzia di un anno contro difetti di fabbricazione o di materiali, sono esclusi dalla garanzia danni derivanti da un cattivo uso o installazione delle apparecchiature.
Le lampade restano comunque escluse dalla garanzia.
Per ogni controversia è competente il Foro di Viterbo.

this page is intentionally left blank / questa pagina è stata lasciata intenzionalmente bianca

this page is intentionally left blank / questa pagina è stata lasciata intenzionalmente bianca

Studio Due[®]

emotion and creativity in light

Head Office: STUDIO DUE s.r.l. (I)

Str. Poggino, 100 - 01100 Viterbo (Italy)
tel. +39.0761.352520
fax +39.0761.352653
info@studiodue.com

STUDIO DUE (UK)

3 Encon Court Owl Close
Moulton Park Industrial Estate
Northampton England UK - NN3 6 HZ
tel. +44.1933.650.820
info@studiodue.co.uk

www.studiodue.com
for technical info
service@studiodue.com