

Studio Due[®]

emotion and creativity in light

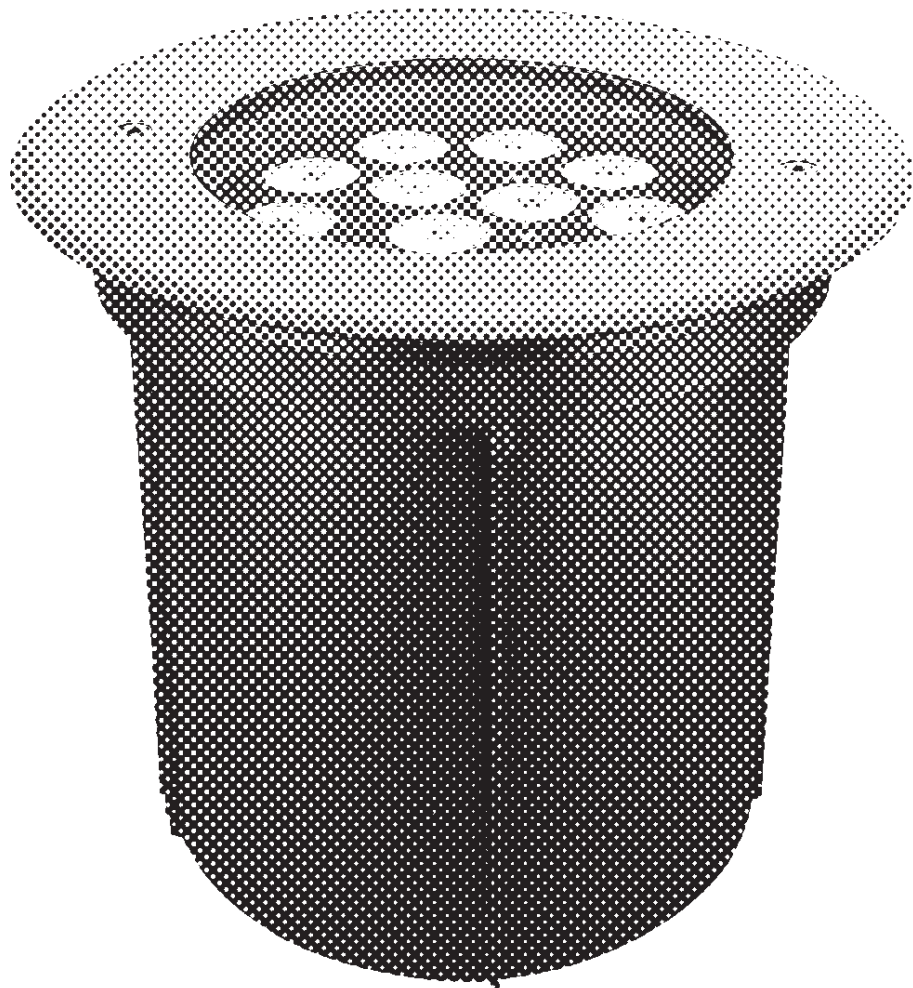

Terra RDM
plus

User manual for art. 1733 - 1734 - 1735
Manuale d'uso per art. 1733 - 1734 - 1735

User manual for art. 1730 - 1731 - 1732 - 1736
Manuale d'uso per art. 1730 - 1731 - 1732 - 1736

this page is intentionally left blank / questa pagina è stata intenzionalmente lasciata vuota

4 PIN connector - Connettore 4 PIN



In this connector you can find the NUMBER 4 or the GROUND sign.

DMX RDM IN-OUT CONNECTION DRS IN CONNECTION

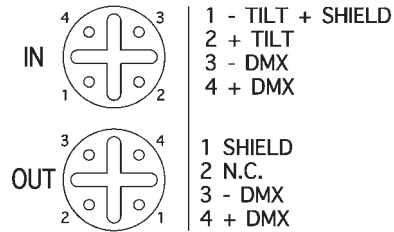

TERRA PLUS-T label

DMX RDM IN-OUT CONNECTION DRS IN CONNECTION

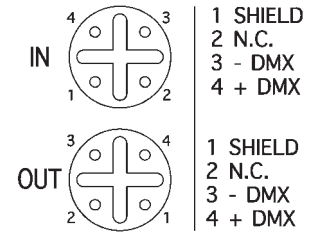

TERRA PLUS label



WARNING
IMPORTANTE

In questo connettore potete trovare il NUMERO 4 o il simbolo della TERRA.

endowed with the fixture - incluso nell'apparecchio

If you want to connect the fixtures for **OUTDOOR** use, you can make a new cable utilizing the **art. 4 PIN-CONN M/F**

The cable is not endowed with the connectors kit

art. 4 PIN-CONN M/F



Se volete utilizzare gli apparecchi all'**ESTERNO**, potete realizzare dei nuovi cavi con **art. 4 PIN-CONN M/F**

Il cavo non è incluso nel kit dei connettori

optional - opzionale



art. 4 PIN/XLR MF
(OPTIONAL)

these **CONNECTORS** are for **INDOOR** use only

questi connettori sono solo per uso **INTERNO**

INDOOR USE ONLY

art. 4 PIN/XLR MF male/female connectors (optional)

art. 4 PIN/XLR MF connettori maschio/femmina (opzionale)

these **CONNECTORS** are **IP67**

questi connettori sono **IP67**

INDEX

Page 5 - Physical / Dimensioni

Page 6 - Locking appliance during transport / Bloccaggio apparecchio durante il trasporto

Page 7 - Fixing of the formwork / Fissaggio della cassaforma

Page 8 - Safety informations / Informazioni di sicurezza

Page 9 - Introduction / Introduzione

Page 10 - Technical features / Caratteristiche tecniche

Page 12 - Example of connection DMX controller-fixtures / Esempio di collegamento centralina DMX-fari

Page 13 - Main supply connection / Collegamento fonte di alimentazione

Page 14 - DMX line connection / Collegamento alla linea DMX

Page 14 - DMX terminal line/ Terminale linea DMX

Page 15 - DRS functioning / Funzionamento del DRS

Page 16 - DRS menu list / Lista menu DRS

Page 17 - Tilt adjustment / Regolazione posizione tilt

Page 18 - DMX Listing / Lista dei canali DMX

Page 21 - CE standards / Certificazioni CE

Page 22 - Warranty / Garanzia

IMPORTANT BEFORE MOUNTING / IMPORTANTE PRIMA DEL MONTAGGIO

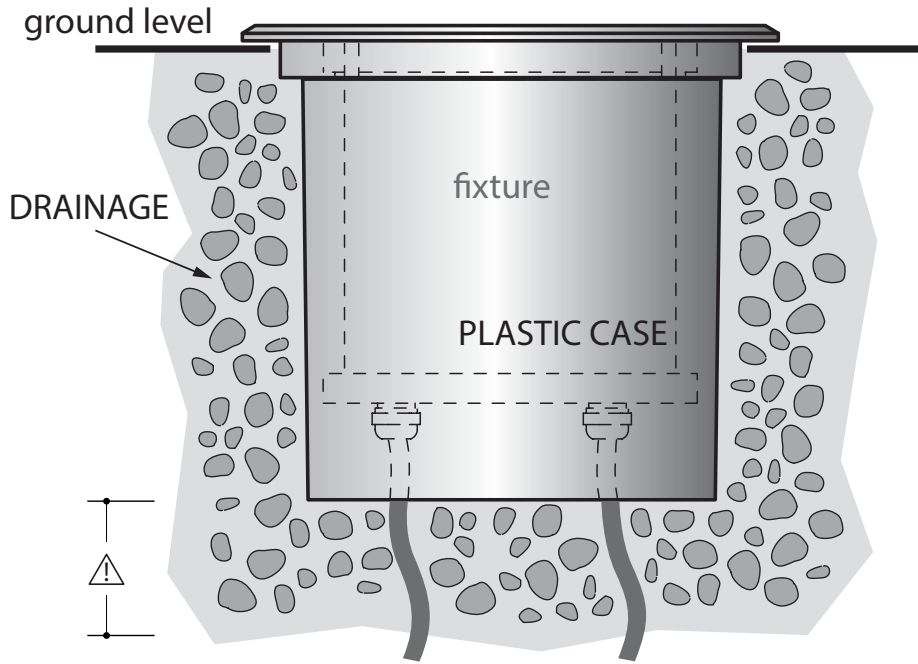

 be sure to create sufficient drainage around the plastic case

PHYSICAL / DIMENSIONI

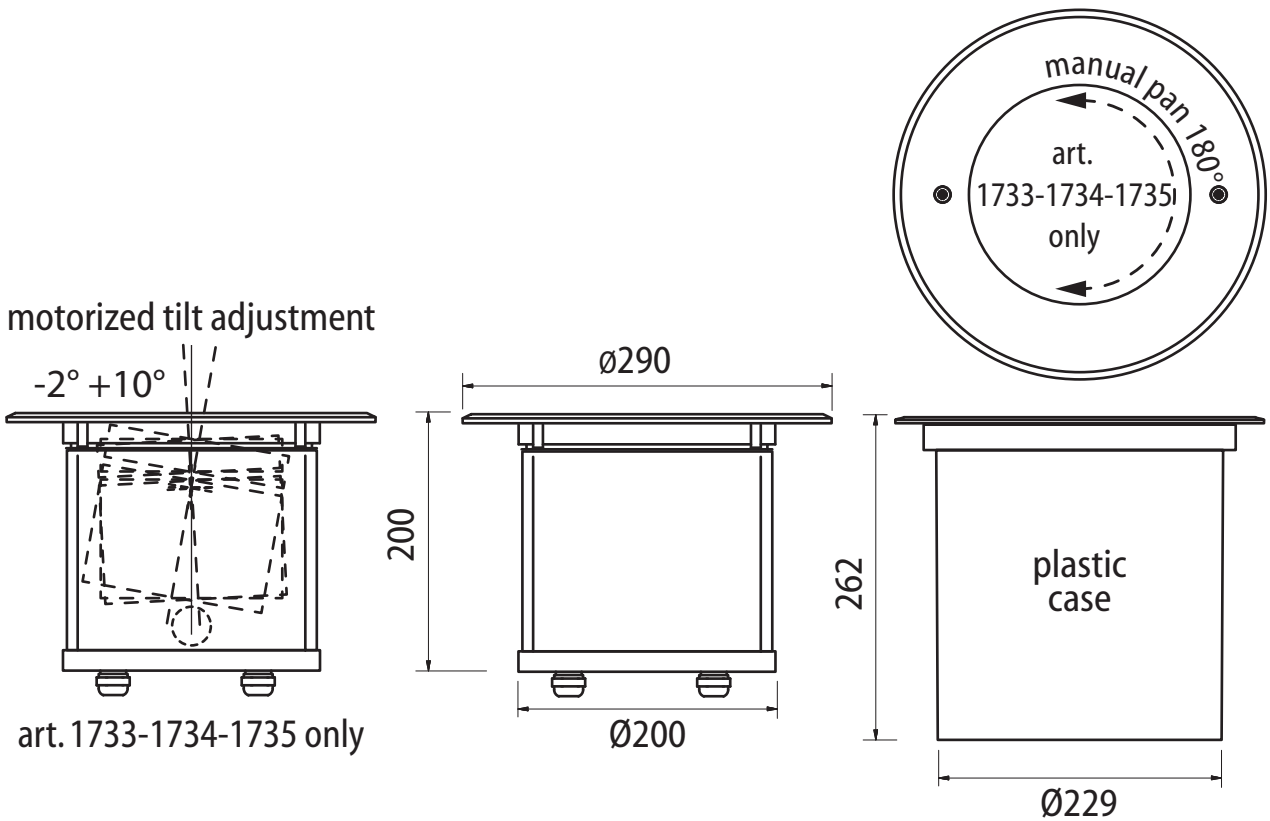

ONLY for version with TILT ADJUSTMENT - remove the label from the glass

**MOTORIZED
TILT ADJUSTMENT**

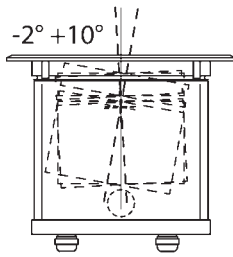

**DO NOT FORCE
NON FORZARE**

When the head of the appliance reaches the limit switch, do not insist on the action.
Motor breakage risk.

Quando la testa dell'apparecchio raggiunge il finecorsa, non insistere con l'azione.
Rischio di rottura del motore.



TERRA PLUS RDM with Plastic Case (included)

ONLY for version with TILT ADJUSTMENT - remove the label from the glass

DURING THE TRANSPORT / DURANTE IL TRASPORTO

! IMPORTANT

DURING TRANSPORT, THE HEAD OF THE APPLIANCE MUST BE LOCKED BY THE TILT LIMIT IN THE POSITION + 10° OR -2°.

OPERATE WITH THE DEDICATED DRS SETUP, MOVING THE HEAD IN ONE OF THESE POSITIONS.

DURANTE IL TRASPORTO, LA TESTA DELL'APPARECCHIO DEVE ESSERE BLOCCATA TRAMITE IL FINE CORSA NELLA POSIZIONE +10° OPPURE -2°.

OPERARE CON IL DRS SETUP DEDICATO SPOSTANDO LA TESTA IN UNA DELLE DUE POSIZIONI.

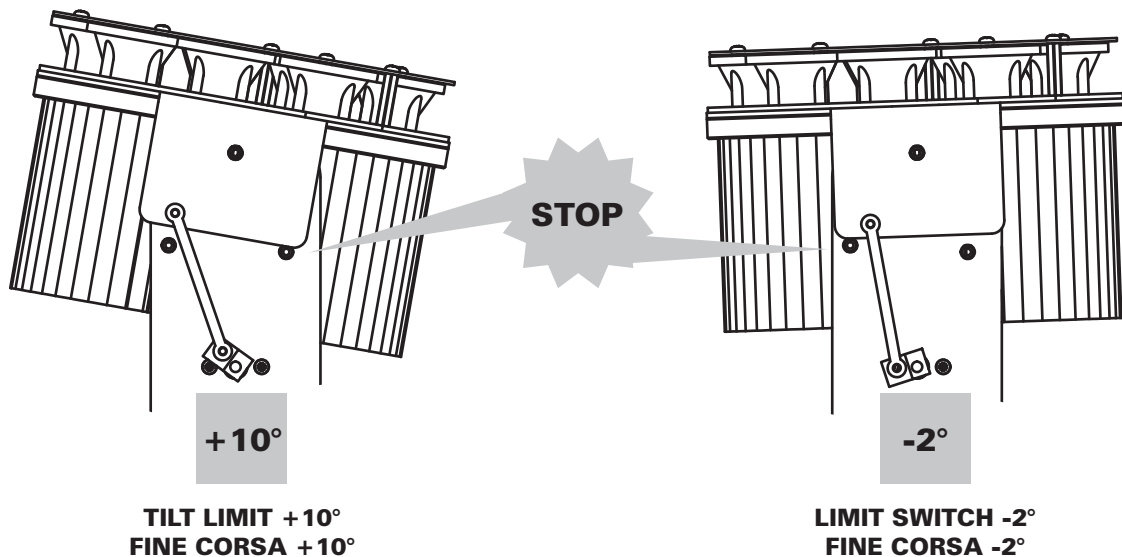

! IMPORTANT

INSTRUCTIONS FOR THE CORRECT APPLICATION OF THE FORMWORK OF THE TERRA PLUS FIXTURES. ALL VERSIONS.

ISTRUZIONI PER LA CORRETTA POSA IN OPERA DELLA CASSAFORMA DEGLI APPARECCHI TERRA PLUS. TUTTE LE VERSIONI.



(c) Formwork / Cassaforma

a) Position (fit) and screw on the formwork the first aluminum adjustment plate (p1). In the opposite position fit and screw the second aluminum adjustment plate (p2) as shown in the picture (a).

Posizionare (inserire) e avvitare sulla cassaforma il primo registro in alluminio di livello terra (p1). Nella posizione opposta, fissare e avvitare la seconda piastra di registro in alluminio (p2) come mostrato nella figura (a).



b) Insert the formwork in the hole created to house the appliance so that the aluminum adjustment plates (p1 and p2) are at the finished installation level (f) and in the correct position.

Posizionare la cassaforma nel foro creato per alloggiare l'apparecchio in modo che le piastre di registro in alluminio (p1 e p2) si trovino al livello finito di installazione (f) e in posizione corretta.



c) The plates p1 and p2 positioned in this way, allow to cement the formwork in the correct position with the finished installation level (f). See picture (c).

Le piastre p1 e p2 posizionate in questo modo, consentono di cementare la cassaforma nella posizione corretta con il livello finito di installazione (f). Vedi immagine (c).



d) Remove the plates p1 and p2. The formwork is now correctly positioned.

Rimuovere le piastre p1 e p2. La cassaforma è ora posizionata in modo corretto



**WARNING****SAFETY INFORMATION (service personnel)**

READ ALL CAUTIONS AND WARNINGS PRIOR TO OPERATE THIS EQUIPMENT.
INSTRUCTION TO PREVENT INJURY OR DAMAGE DUE TO ELECTRIC SHOCK, FIRE, MECHANICAL HAZARDS,
DANGEROUS MATTERS.

•PROTECTION AGAINST DANGEROUS MATTERS

At the end of its life, must be collected separately. It shouldn't be thrown as urban waste and neither released in the environment.

It must be collected from the nearest special waste collection point or consigned to your dealer that provides the service. The incorrect waste disposal can damage the environment and the people for the presence of dangerous substances. Sanctions are provided for an unauthorized disposal.

**•PROTECTION AGAINST FIRE**

- 1) Maintain minimum distance of 0.1 meter from walls or any other type flammable surfaces.
- 2) Maintain minimum distance of 0,1 meter to lighted objects .
- 3) Replace fuses (if present) only with the specified type and rating.
- 4) Do not install the fixture close to heat sources. Do not lay the connection cable on the fixture when it is warm.
- 5) Fixture designed to be installed on normally flammable surfaces.

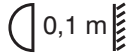
**•PROTECTION AGAINST ELECTRIC SHOCK**

- 1) **This equipment must be earthed.**
- 2) Class I equipment. The power supply cord includes a protective earthing conductor as part of the cord.
- 3) Disconnect power before servicing (service personnel).

**•PROTECTION AGAINST MECHANICAL HAZARDS**

- 1) Use secondary safety chain when fixing this equipment.
- 2) Equipment surface may reach temperature up to 75°C.
- 3) The protection screens and the lenses must be replaced with genuine parts only if they are visibly damaged and their effectiveness has been reduced, for example, by cracks or deep scratches.

**IMPORTANTE****INFORMAZIONI DI SICUREZZA (personale di servizio)**

LEGGERE ATTENTAMENTE TUTTI GLI AVVERTIMENTI PRIMA DI COMPIERE QUALUNQUE OPERAZIONE SU QUESTO APPARECCHIO. ISTRUZIONI PER PREVENIRE LESIONI O DANNI DOVUTI AL FUOCO, ALLE SCOSSE ELETTRICHE, AI RISCHI MECCANICI ED A SOSTANZE PERICOLOSE.

•PROTEZIONE CONTRO SOSTANZE PERICOLOSE

A fine vita è oggetto di raccolta separata, non gettare nei comuni cassonetti di rifiuti urbani, né tantomeno nell'ambiente. Può essere consegnato presso gli appositi centri di raccolta differenziata predisposti dalle amministrazioni comunali, oppure presso i rivenditori che forniscono questo servizio. Lo smaltimento errato può causare danni alle persone e all'ambiente per la possibile presenza di sostanze pericolose. Sono previste sanzioni in caso di smaltimento abusivo dei suddetti prodotti.

**•PROTEZIONE CONTRO IL FUOCO**

- 1) Mantenere la distanza minima di 0.1 metri da pareti ed altre superfici infiammabili.
- 2) Mantenere la distanza minima di 0,1 metri dagli oggetti illuminati.
- 3) Sostituire i fusibili (se presenti) solo con altri dello stesso tipo e valore.
- 4) Non installare il faro vicino fonti di calore. Non appoggiare il cavo di connessione sul faro quando questo è caldo.
- 5) Questo apparecchio è adatto per il montaggio su superfici normalmente infiammabili.

**•PROTEZIONE CONTRO SCOSSE ELETTRICHE**

- 1) **Questo apparecchio necessita di messa a terra.**
- 2) Apparecchio di Classe I. Il conduttore di protezione deve far parte del cavo di alimentazione.
- 3) Disconnettere l'alimentazione prima di aprire l'apparecchio (personale di servizio).

**•PROTEZIONE CONTRO RISCHI MECCANICI**

- 1) Usare la catena di sicurezza supplementare quando installate il faro.
- 2) La temperatura dell'apparecchio può raggiungere 75°C.
- 3) Gli schermi di protezione e le lenti devono essere sostituiti sempre con ricambi originali se sono visibilmente danneggiati e se la loro efficacia è stata ridotta, per esempio, da fessure o incisioni profonde.



INTRODUCTION

Thank you for using TERRA PLUS RDM, our inground LED lighting fixture with powerful LEDs, with IP67 rating protection and in RGBW, WHITE BALANCE or MONOCHROMATIC light source.

• Available two versions: with STATIC OPTICS or with TILT ADJUSTMENT.

It is possible to adjust the TILT position of the fixture only for art. 1733 - 1734 - 1735.

The motorized tilt adjustment function (by dedicated DRS SETUP-T) allows you to position the light beam in the most appropriate way, so it **is not necessary to open the device that maintains the degree of protection IP67**.

Manual Pan 180° and motorized Tilt adjustment -2° + 10°. TERRA PLUS RDM series can be used to decorate columns, pillars, along walkways, on patios, in steps, to highlight and to landscape details and key elements.

• Standard fixture colour finishing is grey.

version with TILT ADJUSTMENT

- Art. 1733 TERRA PLUS-T RDM RGBW;
- Art. 1734 TERRA PLUS-T RDM / WB;
- Art. 1735 TERRA PLUS-T RDM / M

version with STATIC OPTICS

- Art. 1730 TERRA PLUS RDM RGBW;
- Art. 1731 TERRA PLUS RDM / WB;
- Art. 1736 TERRA PLUS RDM / M
- Art. 1732 TERRA PLUS / M (plug-in)

To obtain the best performances and for a correct functioning of this unit for the years to come, we suggest you to read carefully this manual before connecting or putting the fixture into use. By doing so you will gain experience with its commands and connections and you will be easily able to use it.

YOUR REFERENCE

Always remember to give the serial number and to specify the model any time you address the seller for information or assistance.

BASIC KIT

- Projector
- n.2 connectors 4 pin male and female (without cable)
- User manual
- Studio Due warranty
- CE standards



WARNING

Check that the fixture has not been damaged during transport. If it has been damaged or it does not work, address the seller. Whether the fixture has been shipped to you directly, please contact the shipping company. Only the consignee (person or company) can claim for these damages.

ita

INTRODUZIONE

Grazie per utilizzare TERRA PLUS RDM, il nostro apparecchio di illuminazione con potenti LED, protezione IP67 e sorgente luminosa RGBW, WHITE BALANCE o MONOCROMATICA.

• Disponibili in due versioni: con OTTICA STATICA o con REGOLAZIONE TILT.

È possibile regolare la posizione TILT dell'apparecchio solo per l'art. 1733 - 1734 - 1735.

La funzione di regolazione inclinazione motorizzata (con DRS SETUP-T dedicato) consente di posizionare il fascio luminoso nel modo più appropriato, **senza aprire il dispositivo che mantiene così il grado di protezione IP67**.

Pan manuale 180° e regolazione motorizzata Inclinazione -2° + 10°. La serie TERRA PLUS RDM può essere utilizzata per decorare colonne, pilastri, passaggi pedonali, nei cortili, per evidenziare passaggi e ai dettagli paesaggistici o elementi chiave.

• La finitura standard del colore dell'apparecchio è grigio.

versione con TILT ADJUSTMENT

- Art. 1733 TERRA PLUS-T RDM RGBW;
- Art. 1734 TERRA PLUS-T RDM / WB;
- Art. 1735 TERRA PLUS-T RDM / M

versione con OTTICA STATICA

- Art. 1730 TERRA PLUS RDM RGBW;
- Art. 1731 TERRA PLUS RDM / WB;
- Art. 1736 TERRA PLUS RDM / M
- Art. 1732 TERRA PLUS / M (plug-in)

Per ottenere il meglio delle prestazioni ed un corretto funzionamento negli anni di questa unità, Vi consigliamo di leggere attentamente questo manuale prima di collegarla e metterla in uso. In questo modo acquisirete familiarità con i suoi comandi e collegamenti affinché possiate utilizzarla facilmente.

VOSTRA REFERENZA

Citate sempre il numero del modello e di serie ogni volta che Vi rivolgete al vostro rivenditore per informazioni o assistenza.

CONFEZIONE BASE

- Proiettore
- n.2 connettori a 4 pin maschio e femmina (senza cavo)
- Manuale d'uso
- Garanzia Studio Due
- Dichiarazione CE



IMPORTANTE

Controllate che l'apparecchio non abbia subito alcun danno durante il trasporto.

Se avesse subito dei danni o se non dovesse funzionare, rivolgetevi al vostro rivenditore.

Se l'apparecchio vi è stato spedito direttamente, rivolgetevi subito alla ditta di trasporto.

Solo il destinatario (la persona o ditta ricevente l'apparecchio) può reclamare per questo tipo di danni.



version with STATIC OPTICS
• Art. 1730 TERRA PLUS RDM RGBW

version with motorized TILT ADJUSTMENT
• Art. 1733 TERRA PLUS-T RDM RGBW



Inground LED fixture with 12 powerful RGBW LEDs. IP67 rating protection.
Only for art. 1733 is possible to adjust the TILT position of the fixture. Manual Pan 180° and motorized Tilt adjustment -2° +10°. The motorized tilt adjustment function (by dedicated DRS Setup) allows you to position the light beam in the most appropriate way, so it is not necessary to open the device that maintains the degree of protection IP67.

TERRA PLUS RDM RGBW can be used to decorate columns, pillars, along walkways, on patios, in steps, to highlight and to landscape details and key elements.

• Standard fixture colour finishing is grey.

ITEM	FIXTURE	[KEY features]
LEDs	RGBW	12 RGBW
Total light power		40W
Lumen		R 600, G 1100, B 170, W 1200
Optics		15° beam (38 mm lenses) - On request: medium and wide beam
Pan - Tilt	art. 1733 only	Manual Pan 180° - Motorized Tilt adjustment -2°... +10° by DRS Setup (needed)
Power consumption		45W - 0,2A@230V - PF0,9
Voltage range		Universal 100 - 240Vac
Physical		DxH: ø 290x200mm
Weight		5,5 Kg
Control		Standard interface: RS-485, Protocol: RDM / DMX 512, Artnet by external converter
Connections		Main Power: 3x1 cable DMX INPUT and Tilt control: 4 Pin Male IP67 connector DMX OUTPUT: 4 Pin Female IP67 connector
Setup		RDM Control/configuration or individually by DRS (remote control device) Dedicated DMX channel for white balance DMX or Auto mode with Master-Slave function Intelligent temperature control Halogen simulation CYM simulation Flicker-free function Smooth dimming function
DMX channels		10CH mode, 9CH mode, 5CH mode, 4CH mode, 3CH mode



dedicated DRS Setup for Tilt adjustment

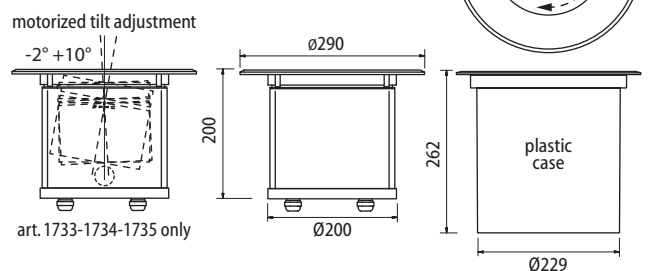

TECHNICAL FEATURES / CARATTERISTICHE TECNICHE art. 1734 - 1735 - 1731 - 1732 - 1736

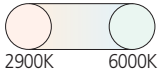

version with STATIC OPTICS
• Art. 1731-1732-1736
TERRA PLUS RDM WB or M

version with motorized TILT ADJUSTMENT
• Art. 1734-1735 TERRA PLUS-T RDM WB or M

manual pan 180°

-2° + 10° motorized tilt adjustment



Inground LED fixture with powerful MONOCHROMATIC LEDs. IP67 rating protection. Only for art. 1734 and 1735 is possible to adjust the TILT position of the fixture. The motorized tilt adjustment function (by dedicated DRS Setup) allows you to position the light beam in the most appropriate way, so it is not necessary to open the device that maintains the degree of protection IP67. Manual Pan 180° and motorized Tilt adjustment -2° + 10°. TERRA PLUS RDM /WB (White Balance) and TERRA PLUS RDM /M (Monochromatic) can be used to decorate columns, pillars, along walkways, on patios, in steps, to highlight and to landscape details and key elements.

• Standard fixture colour finishing is grey

ITEM	FIXTURE	[KEY features]
LEDs	Monochromatic	24 warm, neutral, cool white On request: red, green, blue or amber
	White Balance	12 Cool White + 12 Warm White
Total light power		40W
Lumen		6200 (4000K LEDs)
Optics		15° beam (38 mm lenses) - On request: medium and wide beam
Pan - Tilt	art. 1734 and 1735 only	Manual Pan 180° - Motorized Tilt adjustment -2°... +10° by DRS Setup (needed)
Power consumption		45W - 0,2A@230V - PF0,9
Voltage range		Universal 100 - 240Vac
Physical		DxH: ø 290x200mm
Weight		5,5 Kg
Control		Standard interface: RS-485, Protocol: RDM / DMX 512, Artnet by external converter
Connections		Main Power: 3x1 cable DMX INPUT and Tilt control: 4 Pin Male IP67 connector DMX OUTPUT: 4 Pin Female IP67 connector
Setup		RDM Control/configuration or individually by DRS (remote control device) Dedicated DMX channel for white balance DMX or Auto mode with Master-Slave function Intelligent temperature control Halogen simulation CYM simulation Flicker-free function Smooth dimming function
DMX channels	Monochromatic	3CH mode, 1CH mode
	White Balance	4CH mode, 2CH mode, 1CH mode

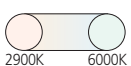

EXAMPLE OF CONNECTION DMX CONTROLLER - FIXTURES / ESEMPIO DI COLLEGAMENTO CENTRALINA - APPARECCHI

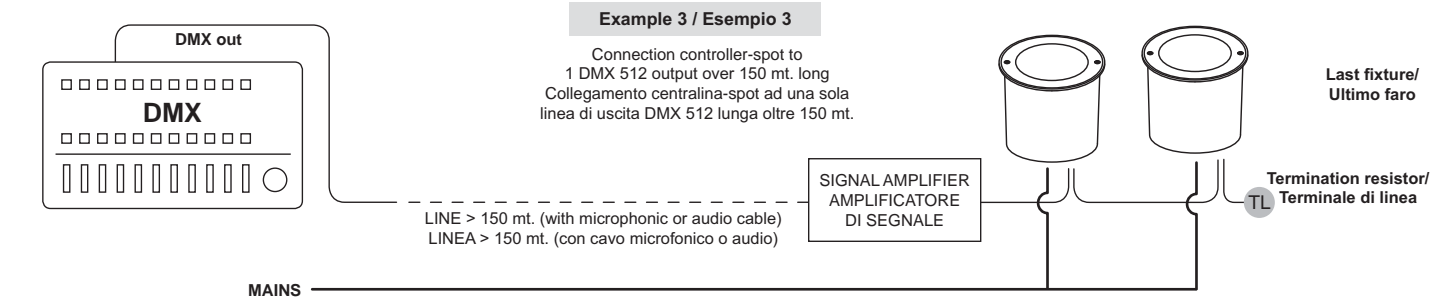
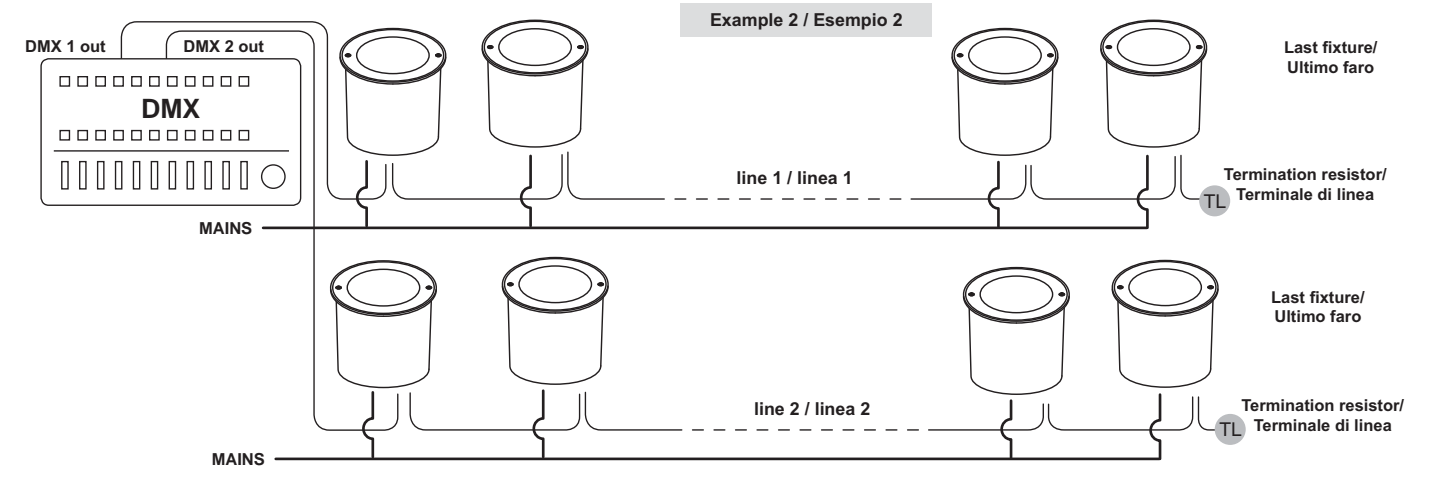
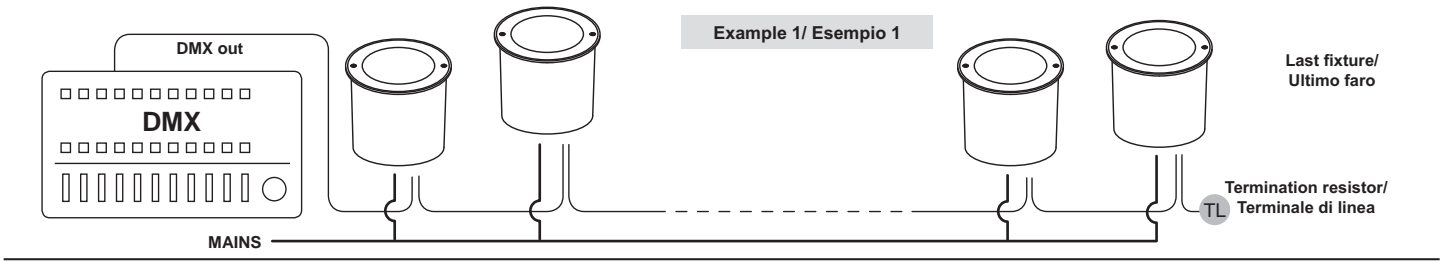

NORMAL AND MASTER/SLAVE FUNCTIONS / FUNZIONI NORMAL E MASTER/SLAVE

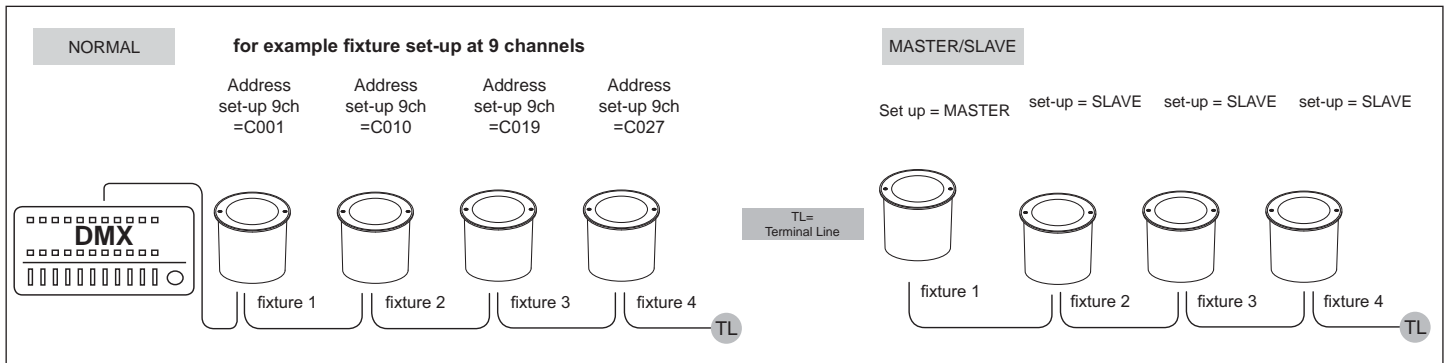

CONNECTION TO THE MAIN POWER / CONNESSIONE ALLA RETE ELETTRICA

This equipment must be earthed.

eng

Class I equipment. The power supply cord includes a protective earthing conductor as part of the cord.

IMPORTANT: to ensure the IP67 protection rating, in case of replacement of the conductor cable, refer to the CONDUCTOR SIZE TABLE

ita

Questo apparecchio necessita di messa a terra.

Apparecchio di Classe I. Il conduttore di protezione deve far parte del cavo di alimentazione.

IMPORTANTE: per garantire il grado di protezione IP67, in caso di sostituzione del cavo di alimentazione, fare riferimento alla TABELLA SEZIONE CONDUTTORE.

WARNING

HIGH VOLTAGE!

Always disconnect the mains supply before access to the connection area.

ALTA TENSIONE!

Scollegare sempre l'alimentazione prima di aprire il vano dei collegamenti.

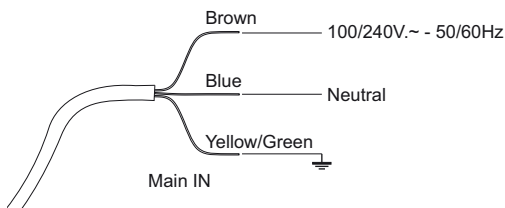

POWER INPUT/ INGRESSO ALIMENTAZIONE Ø 6 - 12mm	
CONDUCTOR SIZES / SEZIONE CONDUTTORE (length / lunghezza < 20mt.)	
MAINS VOLTAGE	CROSS SELECTIONAL AREAS
230V	3X1 mm ² (minimum)

NOT PRESENT in
PLUG IN version

NON PRESENTE
nella
versione PLUG IN



CONNECTION TO THE DMX LINE rear view / CONNESSIONE ALLA LINEA DMX vista posteriore

example of labels / esempi di etichette

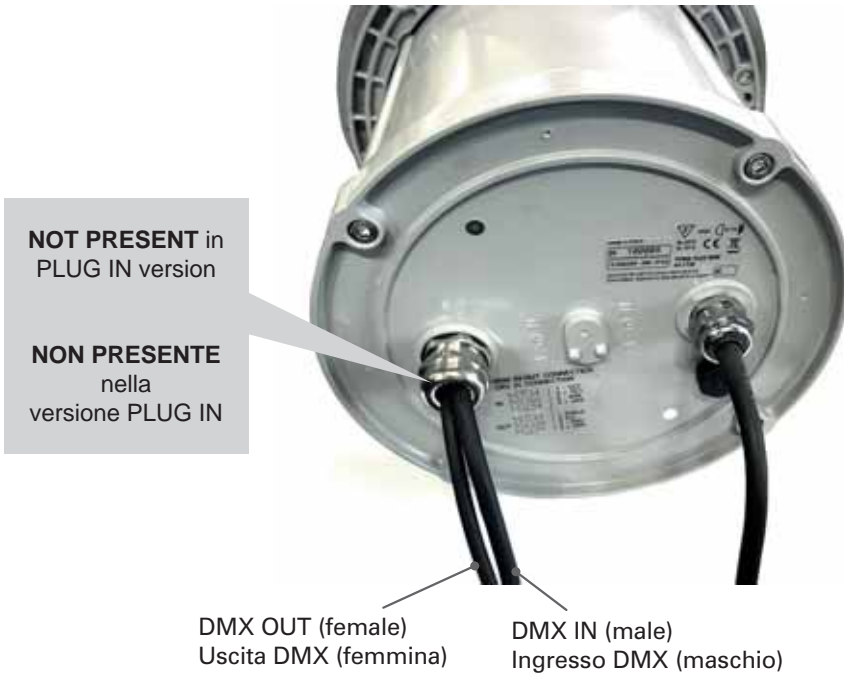

StudioDue®
made in ITALY

IP67 0,1m

Ta 40°C
Tc 75°C

CE

SN

10,2A@230V - 45W - PF 0,9

TERRA PLUS-T RDM rgbw
art.1733

QC

Disconnect the unit from power before servicing.
Disconnettere l'apparecchio dalla rete prima di operare.

DMX OUT (female)
Uscita DMX (femmina)

DMX IN (male)
Ingresso DMX (maschio)

**DMX RDM IN-OUT CONNECTION
DRS IN CONNECTION**

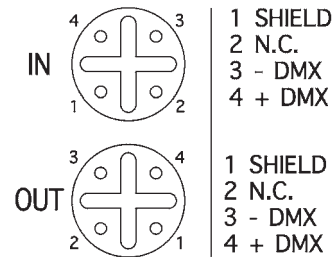

label for fixture
with
STATIC OPTICS

**DMX RDM IN-OUT CONNECTION
DRS IN CONNECTION**

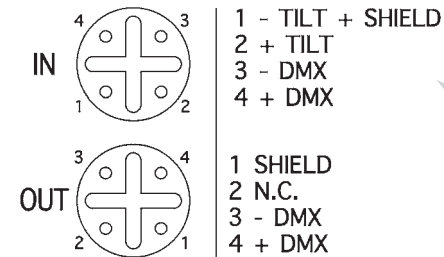

label for fixture
with TILT
ADJUSTMENT

eng

DMX TERMINAL LINE

The wrong connection of the terminal line or its non-connection are probably the most frequent reasons of the lower DMX signal. The terminator is a terminal resistor fitted at the end of the cable. (see pict. 1)
The terminal resistor should have the same value as the impedance of the connection cable (120 Ohm).
It is recommended that all DMX 512 systems have the terminal resistor fitted in the end of DMX line.

ita

TERMINALE LINEA DMX

L'incorretto o il mancato collegamento del terminale di linea è probabilmente la più comune causa del difettoso funzionamento della linea DMX.
Il terminale di linea DMX consiste in una resistenza posta alla fine della linea. (vedere fig. 1)
La resistenza terminale dovrebbe avere lo stesso valore dell'impedenza del cavo di collegamento (120 Ohm).
E' raccomandato per tutti i sistemi DMX 512, di inserire il terminale di linea nel connettore di uscita DMX dell'ultimo apparecchio collegato.

pict. 1

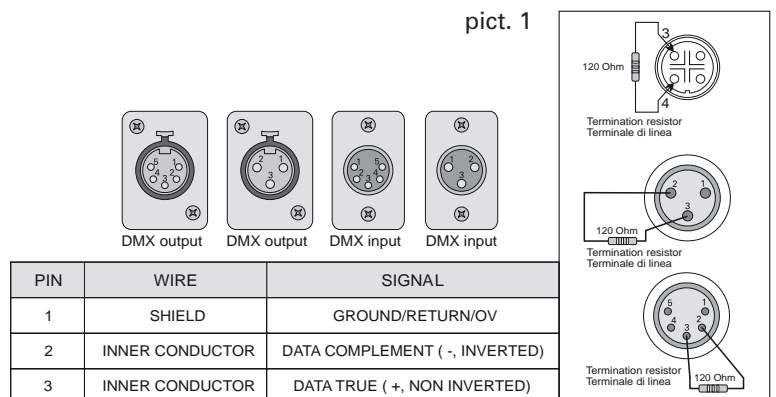

Dedicated DRS (DMX Remote Setup-T) FUNCTIONING with TILT ADJUSTMENT

To make the set-up of the various fixture parameter, proceed as follow:

- Disconnect the fixture to set-up from the other DMX/RDM devices

- Connect the DMX cable of the fixture to the DRS commander

-  Switch on the DRS commander (Press any button) and wait for the **8888** sign

-  If the DRS commander detects a compatible DRS device, displays shortly the **Conn** written and afterwards, displays the name of the fixture and its software version.

-  If the DRS commander don't detects any compatible DRS device or is present any malfunction, the display shows the **SCAn** written

-  When the detection sequence is finished, the display shows the first menu

-  The UP/DOWN buttons allow to scroll forward/backward the menu list

-  The ENTER button allow to confirm the selected option (if the parameter is flashing)

-  The ESC button allow to delete the operation and return to a previous menu level



The DRS SETUP-T device
(for TERRA with TILT ADJUSTMENT)
can also be used for
TERRA with STATIC OPTIC
(ignore the TILT function)

Il dispositivo DRS SETUP-T
(per TERRA con REGOLAZIONE TILT)
può essere utilizzato anche per
TERRA con STATIC OPTIC
(ignorare la funzione TILT)

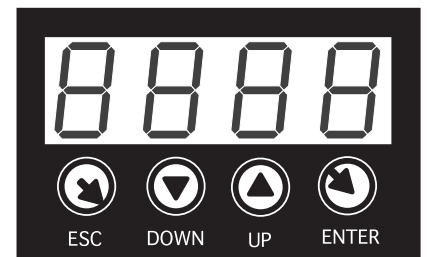
**FUNZIONAMENTO DI BASE DEL DRS dedicato (DMX remote Setup-T) con REGOLAZIONE del TILT**

Per effettuare la programmazione dei vari parametri di un apparecchio, è necessario procedere come segue:

- Disconnettere l'apparecchio da configurare da altri dispositivi DMX/RDM

- Collegare il cavo DMX dell'apparecchio da configurare, al programmatore DRS

-  Accendere il programmatore DRS (premere qualsiasi pulsante) ed attendere che si visualizzi la scritta **8888**

-  Se il programmatore DRS individua un dispositivo DRS compatibile, visualizza per qualche istante la scritta **Conn** e, successivamente, visualizza il nome dell'apparecchio e la relativa versione software

-  Se il programmatore DRS non individua alcun dispositivo DRS compatibile o è presente qualche malfunzionamento il display visualizzerà la scritta **SCAn**

-  Una volta terminata la sequenza di riconoscimento, viene visualizzato il primo menu dell'apparecchio

-  I pulsanti UP/DOWN permettono di scorrere la lista dei menu

-  Il pulsante ENTER permettere di entrare in un menu o di confermare una opzione in caso di lampeggio del parametro

-  Il pulsante ESC annulla una operazione o torna al livello di menu inferiore.

DRS MENU LIST / ELENCO MENU' DRS











Switching on the fixture you can see the model and the software version. For example:

All'accensione, viene visualizzato il modello di apparecchio e la versione software. Per esempio:

--> r - dr --> 1_01

than it's shown the fist menu

poi viene visualizzato il primo menu

Address (Addr)		Imposta l'indirizzo DMX Set the DMX address
Auto Mode (ModE)		Imposta la modalità DMX, SLAVE o MASTER Set the DMX, SLAVE or MASTER mode (no, SL, Pr01...Prxx)
Auto Speed (PrSP)		Imposta la velocità di esecuzione dei giochi interni Set the preset execution speed (-400%...+400%)
N. Channels (nChn)		Imposta il numero di canali DMX dell'apparecchio Set the DMX channels of the fixture (10, 9, 5, 4, 3)
Smooth Dimming (SMth)		Imposta il tipo di interpolazione per la funzione smooth dimming Set the interpolation type for the smooth dimming function (OFF, Sd1, Sd2, Sd3)
Halogen Simulation (HALS)		Imposta il funzionamento della modalità simulazione lampada alogena Set the alogen simulation function mode (OFF, Mod1, Mod2)
CYM Emulation (CYMS)		Imposta l'apparecchio per funzionare come emulatore di sistema CYM o RGB Set the fixture to work in CYM or RGB emulation system (OFF -->RGBW, On -->CYM)
Flicker free function (FLcr)		from 2.09 software version / dalla versione software 2.09 Select the value f1 .. f2 Selezionate il valore desiderato f1 .. f2
Test (tEst)		Abilita il test dell'apparecchio ed esegue un programma di fabbrica per verificarne il funzionamento Enables the test of the fixture and execute a factory program to check the right functioning (OFF, On)
Reset (rSEt)		Esegue un reset della parte elettronica Execute a reset of the electronic section
Format (FrMt)		Ripristina le impostazioni di fabbrica (Viene chiesta conferma) Restore the factory setting (Require confirmation)

TILT ADJUSTMENT with dedicated DRS Setup / REGOLAZIONE posizione TILT con DRS Setup dedicato

DRS Setup is required to adjust the TILT position of the unit. (-2° + 10°)

It is possible to adjust the TILT position of the unit even without connecting it to the mains power supply.

However, we recommend that you select the program 001 (for example red program) in order to see the projected light source and for the correct positioning.

È necessario utilizzare il DRS Setup dedicato, per regolare la posizione TILT dell'unità. (-2° + 10°)

E' possibile la regolazione della posizione del TILT dell'apparecchio anche senza collegare quest'ultimo alla rete elettrica.

Si consiglia comunque di selezionare il programma 001 (per esempio programma rosso) per poter vedere proiettato e per il corretto posizionamento il fascio luminoso.

IMPORTANT

When the head of the appliance reaches the limit switch, do not insist on the action. Motor breakage risk.
Quando la testa dell'apparecchio raggiunge il finecorsa, non insistere con l'azione. Rischio di rottura del motore.

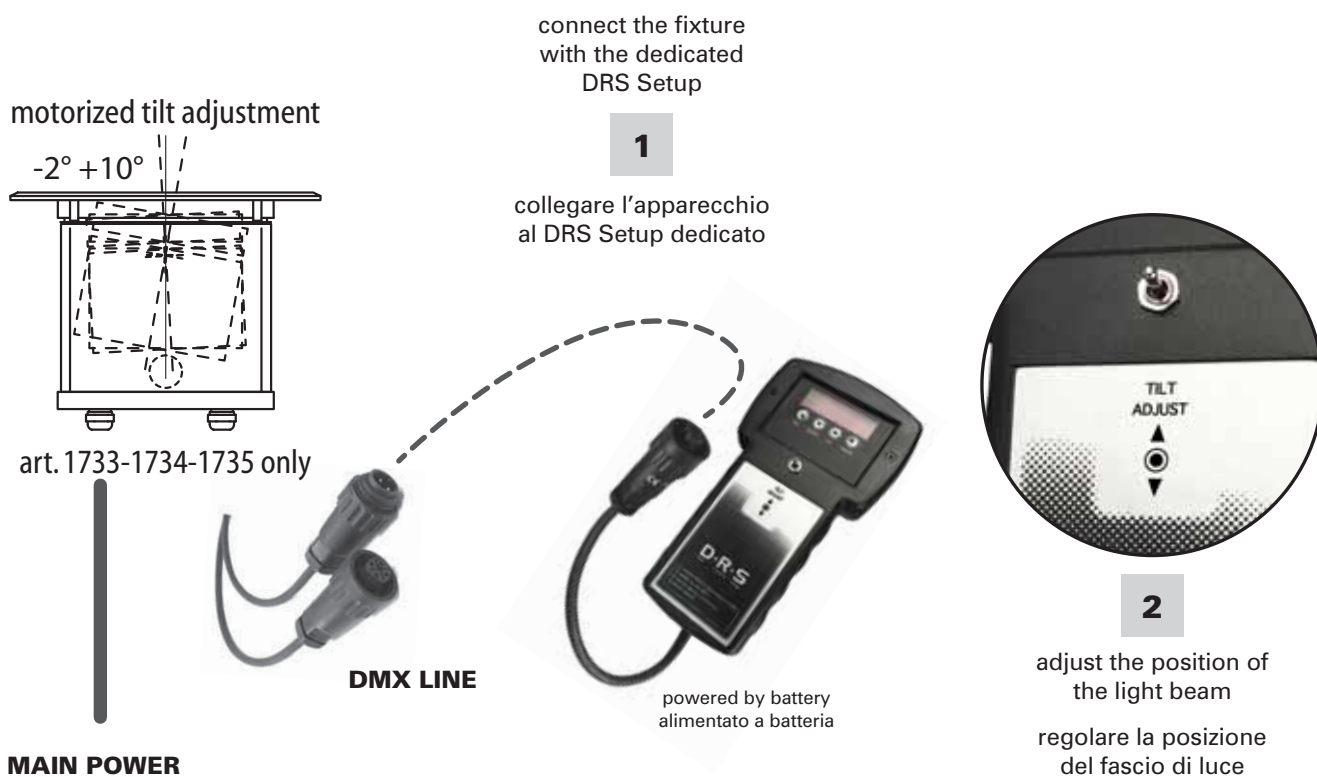

It is possible to adjust the TILT position of the unit even **without connecting it to the mains power supply.**

E' possibile la regolazione della posizione del TILT dell'apparecchio anche **senza collegare quest'ultimo alla rete elettrica.**

IMPORTANT

When the head of the appliance reaches the limit switch, do not insist on the action.
Motor breakage risk.
Quando la testa dell'apparecchio raggiunge il finecorsa, non insistere con l'azione.
Rischio di rottura del motore.

DMX Channels list 10Ch / Lista dei canali DMX 10Ch

8 BIT	FUNCTION	0 31 63 95 127 159 191 233 255
CH1	DIMMER	
CH2	STROBE	
CH3	LED FADE TIME	
CH4	RAINBOW	
CH5	BALANCED WHITE	
CH6	MACRO	
CH7	RED	
CH8	GREEN	
CH9	BLUE	
CH10	WHITE	

DMX Channels list 9Ch / Lista dei canali DMX 9Ch

8 BIT	FUNCTION	0 31 63 95 127 159 191 233 255
CH1	RED	
CH2	GREEN	
CH3	BLUE	
CH4	WHITE	
CH5	STROBE	
CH6	DIMMER	
CH7	LED FADE TIME	
CH8	RAINBOW	
CH9	BALANCED WHITE	

DMX Channels list 5Ch / Lista dei canali DMX 5Ch

8 BIT	FUNCTION	0 31 63 95 127 159 191 233 255
CH1	DIMMER	
CH2	RED	
CH3	GREEN	
CH4	BLUE	
CH5	WHITE	

DMX Channels list 4Ch / Lista dei canali DMX 4Ch

8 BIT	FUNCTION	0 31 63 95 127 159 191 233 255
CH1	RED	
CH2	GREEN	
CH3	BLUE	
CH4	WHITE	

DMX Channels list 3Ch / Lista dei canali DMX 3Ch

8 BIT	FUNCTION	0 31 63 95 127 159 191 233 255
CH1	RED	
CH2	GREEN	
CH3	BLUE	

WHITE BALANCE

DMX Channels list 4Ch / Lista dei canali DMX 4Ch

8 BIT	FUNCTION	0 31 63 95 127 159 191 233 255
CH1	BALANCED WHITE	
CH2	DIMMER	
CH3	STROBE	
CH4	LED FADE TIME	

DMX Channels list 2Ch / Lista dei canali DMX 2Ch

8 BIT	FUNCTION	0 31 63 95 127 159 191 233 255
CH1	BALANCED WHITE	
CH2	DIMMER	

DMX Channels list 1Ch / Lista dei canali DMX 1Ch

8 BIT	FUNCTION	0 31 63 95 127 159 191 233 255
CH1	BALANCED WHITE	

MONOCHROMATIC / MONOCROMATICO

DMX Channels list 3Ch / Lista dei canali DMX 3Ch

8 BIT	FUNCTION	0 31 63 95 127 159 191 233 255
CH1	DIMMER	
CH2	STROBE	
CH3	LED FADE TIME	

DMX Channels list 1Ch / Lista dei canali DMX 1Ch

8 BIT	FUNCTION	0 31 63 95 127 159 191 233 255
CH1	DIMMER	

Dichiarazione CE di conformità Declaration CE of conformity

La ditta: STUDIO DUE light s.r.l.
The firm: Strada Poggino, 100
01100 VITERBO
ITALY

dichiara sotto la propria responsabilità che il prodotto:
declare under our sole responsibility that the product:

TERRA PLUS RDM-T and TERRA PLUS RDM IP67 (series)
code 1733-1734-1735; code 1730-1731-1732-1736

è conforme alle norme: CE
is in conformity with the standard: CE

Low Voltage Directive: 2014/35/EU

EN 60529:1991 + A1:2000 + A2:2013
EN 62471:2008
EN 60598-1:2015
EN 60598-2-17:1989 + A2:1991

ECM Directive: 2014/30/EU

EN 61000-3-2:2014	EN 61000-4-2
EN 61000-3-3:2013	EN 61000-4-3
EN 61547:2009	EN 61000-4-4
EN 55103-2:2009	EN 61000-4-5
EN 55015:2013	EN 61000-4-6
EN 55103-1:2009 + A1:2012	EN 61000-4-11

e quindi ai requisiti essenziali delle Direttive:
and therefore according to essential requirement of Directives:

2004/108/EC – Electromagnetic compatibility
2006/95/EC – Low Voltage directive

Data di apposizione CE : 17
Date of CE marking : 17

VITERBO, 01/06/2017

PAOLO SENSI
General Manager

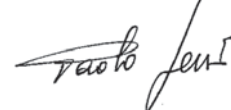

Warranty CARD



Company name:

Mr./Mrs./Miss:

Address:

Tel. or E-mail :

Dealer:

SALE CONDITIONS

1) Price quoted are not inclusive of lamp and package.

Package charge is 2% on the net price for all the items.

These prices should be subject to possible variations for eventual rises of production costs or duties.

Claims for possible damages during the freight, must be notified to the carrier.

Any claim must be notified within 8 days from the receipt of the goods.

The buyer is responsible of the right installation and use of the apparatus.

All the apparatuses are guaranteed for one year against defects of manufacture or materials.

Defects and breakages caused by wrong connection or use of the apparatuses are not subject to guarantee.

The lamp is excluded from the warranty.

For any dispute is competent the Tribunal of Viterbo.

CONDIZIONI DI VENDITA

1) I prezzi riportati sono esclusi di IVA, lampada ed imballaggio.

Il costo di imballaggio è del 2% sul prezzo netto per tutti gli articoli.

Detti prezzi possono essere soggetti a possibili variazioni per eventuali aumenti dei costi di produzione o imposte.

La merce viaggia a rischio e pericolo del committente, anche se in porto franco.

Reclami per possibili danni durante il trasporto, dovranno essere fatti esclusivamente al vettore.

Eventuali osservazioni sulle merci ricevute dovranno esserci notificate entro e non oltre 8 giorni dal ricevimento delle medesime.

Sui ritardi dei pagamenti verrà conteggiato l'interesse commerciale.

L'acquirente si impegna a comunicare la propria esatta ragione sociale e partita IVA al momento dell'ordine e sotto la propria responsabilità di verificarla in fattura.

L'acquirente è responsabile della corretta installazione ed uso delle apparecchiature.

Tutte le apparecchiature godono della garanzia di un anno contro difetti di fabbricazione o di materiali, sono esclusi dalla garanzia danni derivanti da un cattivo uso o installazione delle apparecchiature.

Le lampade restano comunque escluse dalla garanzia.

Per ogni controversia è competente il Foro di Viterbo.

this page is intentionally left blank / questa pagina è stata intenzionalmente lasciata vuota

Studio Due[®]

emotion and creativity in light

Head Office: STUDIO DUE s.r.l. (I)

Str. Poggino, 100 - 01100 Viterbo (Italy)
tel. +39.0761.352520
fax +39.0761.352653
info@studiodue.com

STUDIO DUE (UK)

3 Encon Court Owl Close
Moulton Park Industrial Estate
Northampton England UK - NN3 6 HZ
tel. +44.1933.650.820
info@studiodue.co.uk

www.studiodue.com
for technical info
service@studiodue.com